

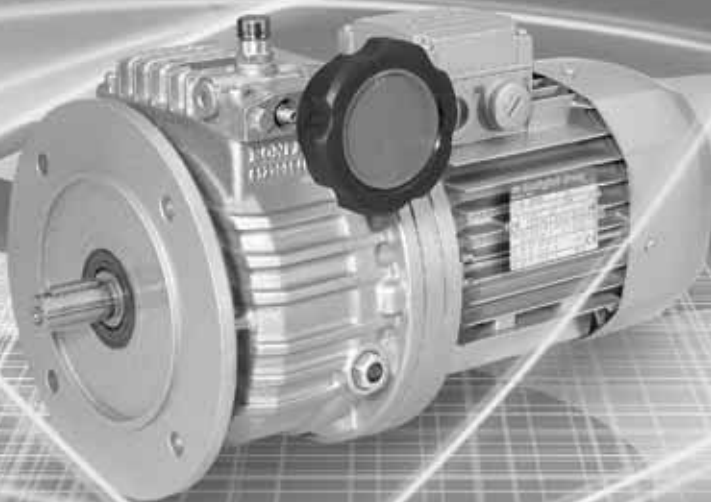

Installation, use and service manual



V



BONFIGLIOLI

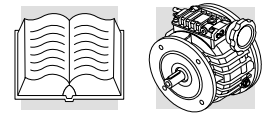

INSTALLATION, USE AND SERVICE MANUAL FOR SPEED VARIATORS



1.0 - GENERAL INFORMATION	2
1.1 - PURPOSE OF THE MANUAL	2
1.2 - IDENTIFICATION OF THE SPEED VARIATOR	3
1.3 - GLOSSARY AND TERMINOLOGY	3
1.4 - REQUESTING TECHNICAL ASSISTANCE	3
1.5 - MANUFACTURER'S LIABILITY	4
2.0 - TECHNICAL INFORMATION	4
2.1 - DESCRIPTION OF THE SPEED VARIATOR	4
2.2 - OPERATING LIMITS AND CONDITIONS	4
3.0 - SAFETY INFORMATION	5
4.0 - HANDLING AND TRANSPORT	6
4.1 - PACKAGING	6
4.2 - HANDLING INSTRUCTIONS	7
4.2.1 - Moving the packages	7
4.2.2 - Moving the equipment	7
4.3 - STORAGE	9
5.0 - INSTALLING THE SPEED VARIATOR	10
5.1 - MOUNTING THE TRANSMISSION COMPONENTS ONTO THE SHAFT	11
5.2 - INSTALLING THE ELECTRIC MOTOR	12
6.0 - TESTING THE SPEED VARIATOR	12
7.0 - USING THE SPEED VARIATOR	13
8.0 - MAINTENANCE	13
8.1 - ROUTINE MAINTENANCE	14
8.2 - LUBRICATION	15
8.3 - REPLACING THE OIL – Speed Variators V1 to V10	18
8.4 - RECOMMENDED LUBRICANTS	18
8.5 - CHECKING EFFICIENCY	19
8.6 - CLEANING	19
8.7 - PAINT COATING	19
9.0 - REPLACING PARTS	19
9.1 - DECOMMISSIONING THE SPEED VARIATOR	19
9.2 - REMOVING THE ELECTRIC MOTOR	20
10.0 - TROUBLESHOOTING	21

Revisions

Refer to page 22 for the catalogue revision index. Visit www.bonfiglioli.com to search for catalogues with up-to-date revisions.

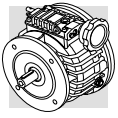

1.0 - GENERAL INFORMATION

1.1 - PURPOSE OF THE MANUAL

This Manufacturer's manual provides information about the safe transport, handling, installation, maintenance, repair, disassembly and dismantling of the speed variator.

All purchasing and design information is given in the Sales Catalogue. Besides adhering to established engineering practices, the information given in this manual must be read carefully and rigorously applied.

Failure to observe the information provided herein may result in risk to personal health and safety, as well as economic damages.

This information, provided in the Manufacturer's original language (Italian), may also be made available in other languages to meet legal and commercial requirements.

The documentation must be stored by a person charged to do so in a suitable location so as to be always available in good condition for consultation.

In case of loss or damage, replacement documentation must be requested directly from the Manufacturer, quoting the code of this manual.

This manual reflects the state of the art at the time of commercialisation of the speed variator.

The Manufacturer reserves the right to modify, supplement and improve the manual, without the present publication being for that reason considered inadequate.

Particularly significant sections of the manual and important specifications are highlighted by symbols whose meanings are given below.

SYMBOLS:



DANGER - WARNING

This symbol indicates situations of danger which, if ignored, may result in serious injury to the operator.



DANGER - WARNING

This symbol indicates the presence of hot surfaces which may burn the operator.



CAUTION - ATTENTION

This symbol indicates the need to adopt specific precautions to avoid personal injury and damages.



IMPORTANT

This symbol indicates important technical information.

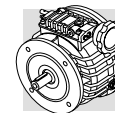
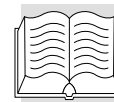

1.2 - IDENTIFICATION OF THE SPEED VARIATOR

The variator is fitted with the nameplate shown below. It indicates all references and indispensable instructions for the safe use of the speed variator. The product identification code is explained in the Sales Catalogue in more detail.

If the speed variator is supplied with integral electric motor (motorised variator), all information regarding the motor itself is supplied in the motor manual.

Nameplate data

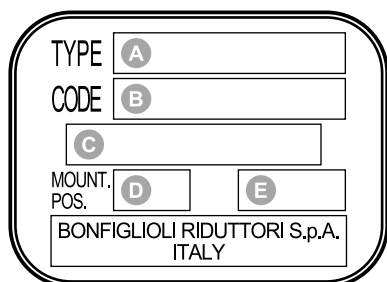

- A** Identification of the variator
- B** Product code
- C** Month / Year of manufacture
- D** Mounting position
- E** Speed variation range

Readability of the nameplate

The nameplate and the information thereon must be kept readable and, consequently must be cleaned from time to time.

Should the nameplate wear or become damaged so as to compromise its readability or that of even one of the items of information thereon, the user must request a new nameplate from the Manufacturer, quoting the information given in this manual, to replace the old one.

1.3 - GLOSSARY AND TERMINOLOGY

Some of the frequently occurring terms used in this manual are described below to unequivocally define their meaning.

Routine maintenance: the set of operations required for maintaining the functionality and efficiency of the speed variator. These operations are usually scheduled by the Manufacturer, who defines the qualifications and tasks in question.

Non-routine maintenance: the set of operations required for maintaining the functionality and efficiency of the speed variator. These operations are not scheduled by the Manufacturer and must be carried out by an expert maintenance technician.

Expert maintenance technician: an authorised technician selected from those having the qualifications, skills and mechanical and electrical training to carry out repairs and non-routine maintenance work on the speed variator.

Overhaul: an overhaul consists of the replacement of bearings and/or other mechanical components which have worn to such an extent as to compromise the operation of the speed variator. An overhaul also includes checking the condition of all variator components (keys, seals, gaskets, vents, etc.). If any such components are damaged they must be replaced and the reason for the damage identified.

1.4 - REQUESTING TECHNICAL ASSISTANCE

For any technical service needs, contact the Manufacturer's sales network, quoting the information indicated on the unit's nameplate, the approximate hours of service and the type of defect.

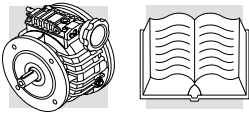

1.5 - MANUFACTURER'S LIABILITY

The Manufacturer declines all liability in the event of:

- use of the speed variator in violation of local legislation on safety and accident prevention at work
- incorrect installation and disregard or incorrect application of the instructions provided in this manual
- incorrect or defective power supply (motorised speed variators)
- modifications or tampering
- work done on the unit by unqualified or unsuitable persons.

The safe use of the speed variator also depends on scrupulous observance of the instructions given in this manual. In particular:

- always operate the speed variator within its operating limits
- diligently observe the routine maintenance schedule
- only authorise trained operators to inspect and service the unit
- use only original spare parts.

2.0 - TECHNICAL INFORMATION

2.1 - DESCRIPTION OF THE SPEED VARIATOR

The speed variator has been designed and constructed for integration, driven, if required, by an electric motor, into an assembly of interlocking parts or mechanisms as part of a specific application.

Depending on the requirements of the application, the speed variator can be supplied in a variety of motor executions and configurations. It is capable of satisfying a range of specific requirements in the mechanical, chemical, agricultural and food industries, etc.

BONFIGLIOLI RIDUTTORI supplies a range of accessories and optionals to make their products as versatile as possible. For further technical information and descriptions, refer to the Sales Catalogue.

The user is responsible for using the products recommended for installation and maintenance of BONFIGLIOLI speed variators in an appropriate manner and in accordance with instructions.

2.2 - OPERATING LIMITS AND CONDITIONS

Ambient conditions

- Ambient temperature: min. - 20°C; max. + 50°C.
- Do not use the speed variator, if not explicitly intended for the purpose, in a potentially explosive atmosphere or where the use of explosion-proof equipment is specified.
- Noise - Vibration

During operational testing at the Manufacturer's premises, the acoustic pressure measured under full load at a distance of 1 m from the unit and 1.6 m above ground level without echo was less than 85 dB(A).

The vibrations produced by the speed variator do not constitute a health risk for personnel. Excessive vibration may be the result of a fault, which should be immediately reported and eliminated.

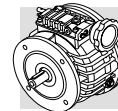

3.0 - SAFETY INFORMATION

- Carefully read the instructions given in this manual and those indicated on the product itself, especially regarding safety.
- Persons charged with working on the speed variator at any time during its service life must be trained specifically for the purpose and possess the special skills and experience in the area, as well as being equipped with and knowledgeable in the use of the appropriate tools and individual safety equipment (as per Legislative Decree 626/94). Failure to meet these requirements constitutes a risk to personal health and safety.
- Use the speed variator only for the applications envisaged by the Manufacturer. Improper use can result in risks to personal health and safety and economic damages.



The applications permitted by the Manufacturer are the industrial applications for which the V series speed variators have been developed.

- Keep the speed variator at its maximum efficiency by following the routine maintenance schedule. Good maintenance ensures the unit's maximum performance, an extended service life and continued compliance with safety regulations.
- When working on the unit in areas which are difficult to access or hazardous, ensure that adequate safety precautions have been taken for the operator and others in compliance with applicable laws on health and safety at work.
- All maintenance, inspection and repairs must only be carried out by an expert maintenance technician fully familiar with the attendant hazards. It is therefore essential to implement operating procedures which address potential hazards and their prevention for the entire machine. The expert maintenance technician must always work with caution in observance of applicable safety standards.
- During operation wear only the apparel and safety equipment indicated in the User Instructions provided by the Manufacturer or stipulated by laws on health and safety at work.
- Replace worn components with original spare parts. Use the lubricants (oil and grease) recommended by the Manufacturer.
- Do not dump polluting materials into the environment. Dispose of all such materials as stipulated by applicable legislation.
- After replacing lubricants clean the speed variator's surfaces and walk-on surfaces around the work area.

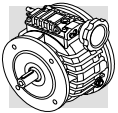

4.0 - HANDLING AND TRANSPORT

4.1 - PACKAGING

The standard packaging, if supplied, and unless otherwise agreed, is not proofed against rainfall and is intended for shipping by ground and not sea, and for storage in areas which are under cover and not humid. The material can be stored in suitable conditions for a period of two years under cover in temperatures between -15 °C and +50 °C at a relative humidity not in excess of 80%. Storage in all other conditions requires specific packaging.

In order to facilitate handling, heavy packages can be loaded on pallets.

The most frequent types of packaging are shown in the figures below.

- Wooden crates for miscellaneous products shipped by sea.



- Carton pallet packaging for single products and kits.

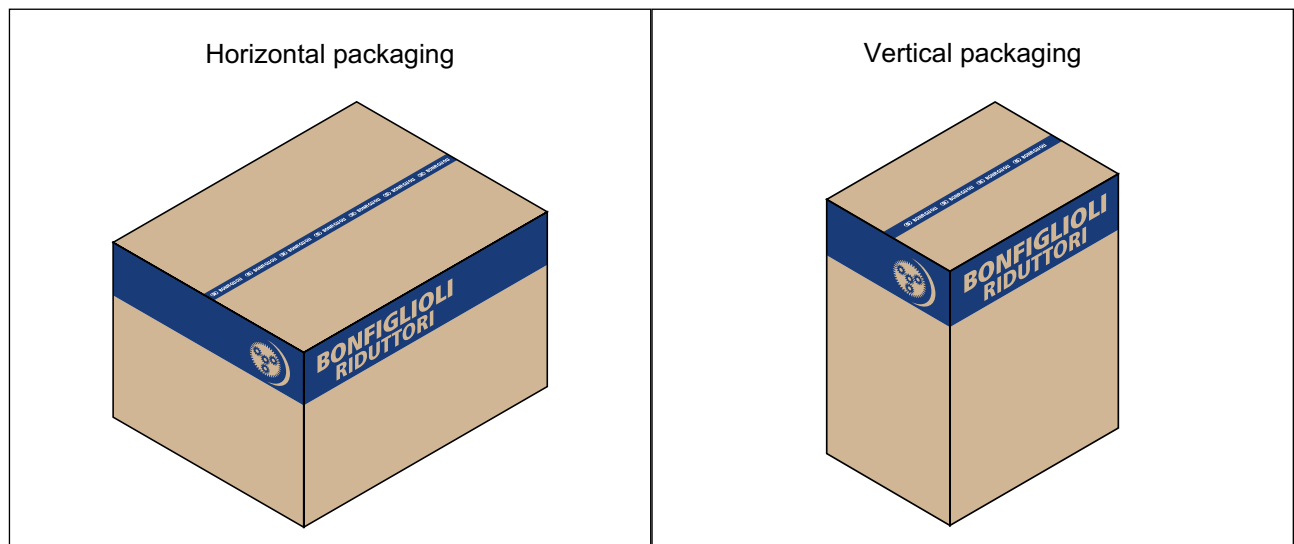

On receipt of the speed variator, make sure the delivery corresponds to the purchase order and that it is not damaged or faulty in any way. Report any nonconformity to your BONFIGLIOLI RIDUTTORI reseller.

Dispose of packaging materials as stipulated by applicable legislation.

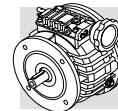
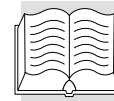

4.2 - HANDLING INSTRUCTIONS

Handle packages as per the Manufacturer's instructions and those indicated on the packages themselves. Since the weight and shape of the packages may make manual handling unfeasible, special equipment must be used to avoid damage and injury. Persons authorised for this purpose must be trained and experienced in the work in question to avoid risks to themselves and other persons.



The person authorised to handle the product must take all necessary precautions to safeguard his safety and that of all other persons involved.

4.2.1 - Moving the packages

- Prepare a suitable, delimited area with a level floor or surface for unloading the packages.
- Prepare the equipment required for handling the package. The lifting and handling equipment (e.g. crane or lift truck) must be of adequate capacity for the weight and size of the load, taking into account its attachment points and centre of gravity. If required, this information is indicated on the package itself. Harness heavy packages with chains, belts and steel ropes after checking that they are suitable for the weight of the load, which is always specified.
- When handling the load keep it level to avoid tipping and instability.

4.2.2 - Moving the equipment



All the following operations must be carried out with care and caution and without sudden movements.

When lifting, use accessories such as eyebolts, screw clamps, snap hooks, straps, ropes and hooks etc. which are certified and adequate for the load in question.

The weight of the product to be lifted is given in the Sales Catalogue.

- Identify the attachment points for lifting the speed variator. Refer to the diagram below for this information.
- Prepare the speed variator for lifting by attaching straps, hooks and screw clamps, etc. to its attachment points, or alternatively, use a pallet for moving the load. If using a crane, first lift the speed variator vertically out of its packaging.
- If using a lift truck or pallet truck, remove the packaging and insert the truck's forks at the indicated points.
- First lift the load very slowly to check that it is stable.
- Move the speed variator to the unloading area and lower it gently into position, taking care not to cause sudden oscillations while moving it.



If the speed variator is coupled to an electric motor, do not use the eye-bolts on the motor for lifting the entire load, unless this is expressly indicated.

V+BN
VR+BN

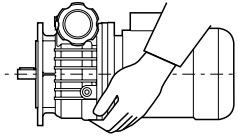

V, VR 0.25

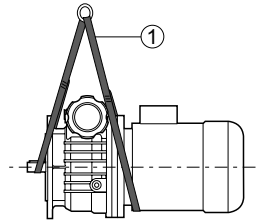

V 0.5 ... V 10

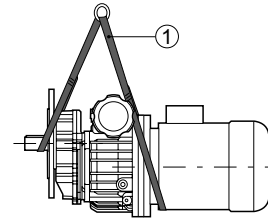

VR 0.5 ... VR 10

INPUT
P(IEC)

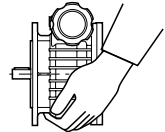

V, VR 0.25 - 0.5

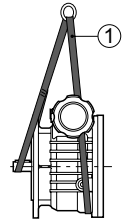

V 1 - V 2

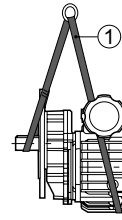

VR 1 - VR 2

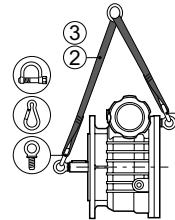

V 3 - V 5.5

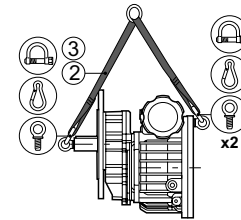

VR 3 - VR 5.5

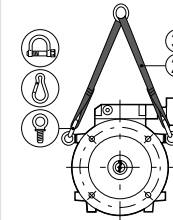

V, VR 10

INPUT
HS

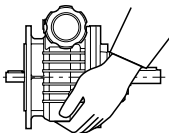

V, VR 0.25 - 0.5

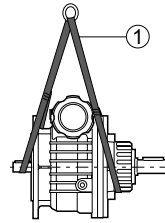

V 1 ... V 5.5

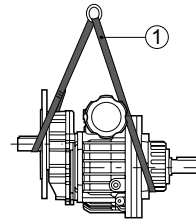

VR 1 ... VR 5.5

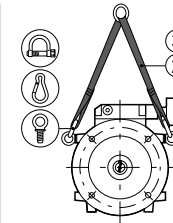

V, VR 10

INPUT
ENTG(IEC)
ENTN(NEMA)
ENTHS

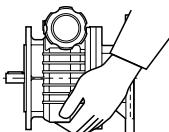

V, VR 0.25 - 0.5

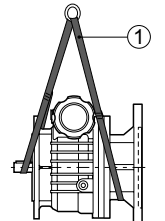

V 1 ... V 5.5

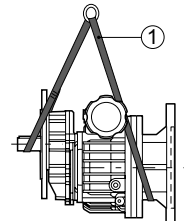

VR 1 ... VR 5.5

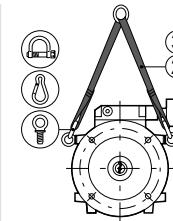

V, VR 10

Maximum permissible tilt during handling

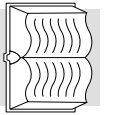
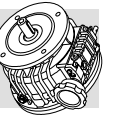
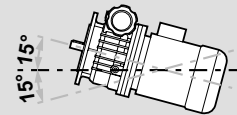

Equipment not supplied

- ① Ring harness
- ② Rope and hooks
- ③ Open harness with eyelets
-  Screw clamp (use with harness)
-  Snap hook (use with rope)
-  Eyebolt

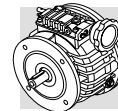
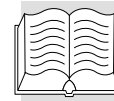

The load must not be allowed to swing up or down by more than 15° when being lifted. If swinging exceeds this angle, stop and repeat the lifting operation, stabilising the load by hand.

If the mass being lifted shows signs of instability, stop the operation and slide the lifting ring to align it with the load's centre of gravity, then lock the ropes below the ring with a clamp, or similar device, so as to prevent them sliding, and lift the load.

4.3 - STORAGE

Some recommendations for storing the speed variator are described below.

1. Do not store the unit in excessively humid conditions or exposed to the weather (do not store outdoors).
2. Do not place the speed variator directly on the ground.
3. Place the variator on a stable base and make sure that it is not subject to accidental displacement.
4. Store the packaged variator (if allowed) in accordance with the instructions on the packaging itself.

If the unit is to be stored for more than 6 months, the following **additional** precautions must be taken:

5. Cover all machined external surfaces with a rustproofing product such as Shell Ensis or other product with similar properties and application range.
6. Fill the unit with lubricating oil.

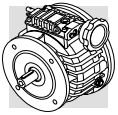

5.0 - INSTALLING THE SPEED VARIATOR



The entire installation process must be planned based on the general design of the machine. The person authorised to do the work must, if necessary, set out a safety plan to protect the health and safety of all persons directly involved and apply all applicable legislation.

1. Carefully remove all packaging and protective product residue from the speed variator. Pay particular attention to the coupling surfaces.
2. Check that the data on the nameplate correspond to those specified in the order.
3. Ensure that the structure to which the speed variator is to be mounted is sufficiently robust and rigid to support its weight and operating stresses.
4. Make sure that the machine on which the speed variator is to be installed is switched off and cannot be accidentally switched on again.
5. Check that all coupling surfaces are flat.
6. Check that the shaft/shaft or shaft/ bore are perfectly aligned for coupling.
7. Fit suitable guards to protect against the speed variator's external moving parts and the risk of burns from its hot surfaces.
8. If the work environment is corrosive for the speed variator or any of its parts, take the special precautions required for aggressive environments. In this case, contact the BONFIGLIOLI RIDUTTORI sales service.
9. We recommend applying a protective paste to all couplings between the speed variator/motor and other parts (Klüberpaste 46 MR 401, or a product with similar properties and application range) to ensure optimal coupling and protection against fretting corrosion.
10. In case of outdoor installations fitted with an electric motor, protect the latter from direct sunlight and the weather by means of guards or a casing. Make sure that the assembly is properly ventilated.



The variator's speed settings must only be set with the unit powered up and operating. Operating the handwheel or the remote speed controls while the variator is stationary can irreversibly damage its internal components.

Now proceed with the installation as follows:

1. Place the speed variator in the vicinity of the installation area.
2. Mount the speed variator and secure it to the structure at the points provided. The speed variator should be secured to the structure at all mounting points (bores) on the mount provided (feet or flange).
3. Identify the closed oil plug used during shipping (usually red) and replace it with the vent plug provided in the shipment. Refer to the charts in the "Speed variator lubrication" chapter.
4. Tighten down the mounting bolts and check that the service caps are screwed down to the torques given in the table below (A1).

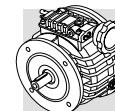
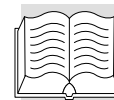

(A1)

Bolt size	Bolt torque [Nm]	
	Bolt class	
	8.8	10.9
M4	2.7	3.8
M5	5.5	8.0
M6	9.5	13.0
M8	23	32
M10	46	64
M12	80	110
M14	125	180
M16	195	275
M18	270	390
M20	385	540

cap/vent thread	Pitch	Torque [Nm]
1/8"	28	5
1/4"	19	7
3/8"	19	7
1/2"	14	14
3/4"	14	14
1"	11	25

5.1 - MOUNTING THE TRANSMISSION COMPONENTS ONTO THE SHAFT



When mounting external parts do not use hammers or other tools which might damage the speed variator's shafts or bearings. Instead proceed as illustrated in the diagram below:

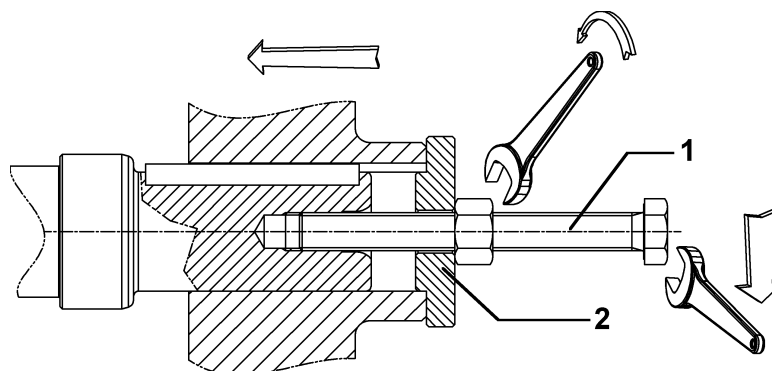

Bolt (1) and spacer (2) are not included in the consignment.

To minimize the loads on the shaft bearings, when mounting transmission mechanisms with asymmetrical hubs, use the configuration shown in diagram (A) below:

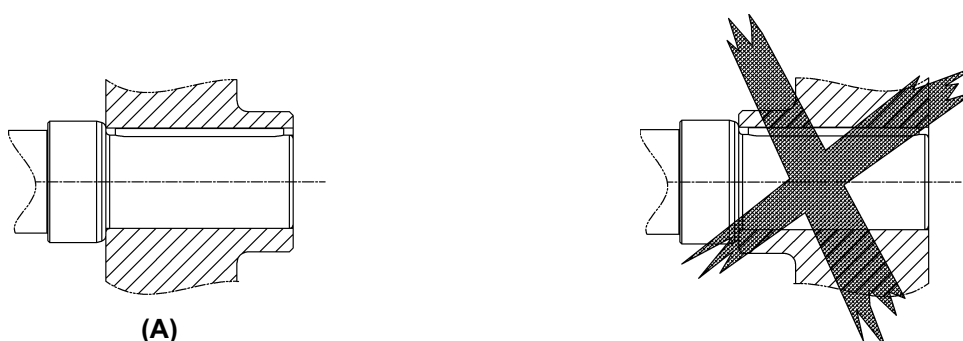

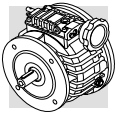

5.2 - INSTALLING THE ELECTRIC MOTOR

Further to all the precautions indicated above, when installing an electric motor standardised to IEC 72-1 requirements, the following precautions must also be observed:

- Do not force the coupling and do not use inappropriate tools during assembly. Take care not to damage the flat/cylindrical coupling surfaces.
- Do not force the rotary coupling mechanisms with large radial or thrust loads.
- To facilitate assembly, use a lubricating synthetic oil paste such as Klüberpaste 46 MR 401 or other product with similar properties and application range.
- Tighten down all motor/variator mounting bolts to their prescribed torques. For the tightening torques, refer to chart (A1) above.
- For speed variators with a differential unit (VD), only use electric motors featuring an oil seal on the shaft.

6.0 - TESTING THE SPEED VARIATOR

The speed variator has been factory tested by the Manufacturer.

Before starting the unit, check that:

- the machine incorporating the speed variator complies with the provisions of "Machine Directive" 98/37/EC and any other applicable safety laws
- the speed variator's mounting position in the installation corresponds to that prescribed and indicated on the nameplate
- the electrical power supply is suitable and operational as specified by standard EN 60204-1, and is grounded as per standard EN 50014
- the power supply rating corresponds to that prescribed and is within +/- 5% of the rated value
- the oil level is as prescribed and that there are no leaks from the caps or gaskets
- the vent plug is correctly installed and that its hole is not obstructed by dust or other foreign bodies
- the unit does not run noisily or with excessive vibration.



For an initial running-in period of approx. 150-200 hours, due to settling in of the moving parts, it is normal for the operating temperature to be higher than that experienced thereafter.

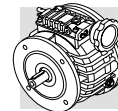
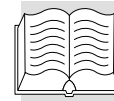

7.0 - USING THE SPEED VARIATOR

Before putting the speed variator into service, the user must ensure that the plant in which it is installed complies with all applicable directives, especially those regarding health and safety at work.

During operation, avoid frequent starts of the motor as these can reduce the unit's service life. Starts should not exceed 8 to 10 per minute.

Using the speed variator at a drive speed $n_1 \leq 300$ rpm is inadvisable as this may lead to irregular operation of the unit.



The speed variator may reach high temperatures even under no load or with reduced load. Therefore, do not touch with bare hands.



The speed variator may not be used in areas and environments:

- with highly corrosive/abrasive vapours, smoke or dust
- in direct contact with loose food products.



Danger zones and exposed persons:

The variator's danger zone is the protrusion of the shaft which constitutes a hazard for exposed persons in direct contact with it (crushing, cutting, trapping). In particular, when the variator is operating in automatic mode and in an accessible area, the shaft must be protected by a guard.

8.0 - MAINTENANCE



Maintenance and replacement work must be carried out by expert maintenance technicians trained in the observance of applicable laws on health and safety at work and the special ambient problems attendant on the installation.



Before doing any work on the unit, the operator must first switch off power to the speed variator's motor and ensure that it is out of service, as well as taking all necessary precautions against it being accidentally switched on again or its parts moving without warning (due to suspended loads or similar external factors).

Furthermore, all additional environmental safety precautions must be taken (e.g. elimination of residual gas or dust, etc.).

- Before doing any maintenance work, activate all the safety devices provided and, if necessary, inform persons working in the vicinity. In particular, mark off the area around the unit and prevent access to any equipment which, if activated, might be the cause of unexpected health and safety hazards.
- Replace worn components with original spare parts.
- Use the lubricants (oil and grease) recommended by the Manufacturer.
- When working on the speed variator always replace the gaskets and seals with new original ones.
- If a bearing requires replacement, it is good practice to also replace the other bearing supporting the same shaft.
- We recommend replacing the lubricating oil after all maintenance work.

The above instructions are aimed at ensuring efficient and safe operation of the speed variator.

The Manufacturer declines all liability for injury to persons and damage to components due to the use of non-original spare parts and non-routine work which modifies the safety requirements without the manufacturer's express prior authorisation.

Refer to the specific spare parts catalogue when ordering spare parts for the speed variator



Do not dump polluting liquids, worn parts and maintenance waste into the environment. Dispose of all such materials as specified by applicable law.

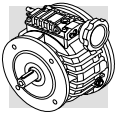

8.1 - ROUTINE MAINTENANCE



Keep the speed variator at its maximum efficiency by following the routine maintenance schedule specified by the Manufacturer.

Good maintenance ensures the unit's maximum performance, extended service life and continued compliance with safety regulations.

Speed variators V0.25 and V0.5

These units are factory charged with long-life synthetic lubricant Shell Donax TX and do not have service plugs. Speed variators which are not subject to external contamination do not normally require periodic lubricant changes.

Speed variators V1 to V10

It is advisable to change the lubricant after approx. 300 hours of operation, having first carefully and thoroughly cleaned the interior of the unit with a suitable detergent.

Depending on the temperature reached by the lubricant, it should be replaced at the intervals indicated in the table below:

(A2)

Oil temperature t [°C]	Oil change frequency [h]
$65 \leq t < 80$	4000
$80 \leq t \leq 95$	2000

Interval	Part	Type of check	Action
1000 h	Oil seals and gaskets	Visual check of oil level Visual check for leaks	Top up lubricant Service or replace components as required
4000 h	Oil seals and gaskets	In addition to the operations specified after 1000 h: Inspect carefully for wear/ageing of oil seals and gaskets	Replace components if aged/worn
	Transmission parts	Check for excessive noise or vibration	

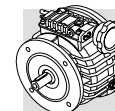
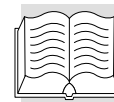

8.2 – LUBRICATION

Before operating the speed variator, check the oil level through the sight glass, if fitted. This must be done with the speed variator in the mounting position in which it will be installed. If necessary, refill or top up the lubricant.

Speed variators type V 0.25 and V 0.5 are factory filled with long-life synthetic lubricant **Shell Donax TX** and do not have service plugs. Speed variators which are not subject to external contamination do not normally require periodic lubricant changes. If a top-up or complete lubricant change is necessary, strictly observe the quantities given in the tables below.

Do not mix oils of different types. Changes and top-ups must always be done with the same type of lubricant. If the same type of oil as that already in use is not available, drain the speed variator casing completely and flush the interior thoroughly with a light solvent before refilling with a new lubricant.

Shell Donax TX (indicative features)			
Density	ISO 3675	0.852	Kg/dm ³
Kinematic viscosity 40 °C	ISO 3104	34	cSt
Kinematic viscosity 100 °C	ISO 3104	7.4	cSt
Viscosity index	ISO 2909	196	-
Flash point	ISO 2592	198	°C
Pour point	ISO 3016	-48	°C

Speed variators V1 to V10 are supplied already charged with mineral oil **Shell Donax TA**. Changes and top-ups must always be done with a compatible type of lubricant. Do not in any case mix mineral and synthetic oils.

Shell Donax TA (indicative features)			
Density	ISO 3675	0.873	Kg/dm ³
Kinematic viscosity 40 °C	ISO 3104	37.3	cSt
Kinematic viscosity 100 °C	ISO 3104	7.0	cSt
Viscosity index	ISO 2909	151	-
Flash point	ISO 2592	196	°C
Pour point	ISO 3016	-42	°C

The helical reduction gear pair on **VR** variators is lubricated with long-life grease **Shell TVX Compound B**. Speed variators fitted with a differential unit (**VD**), are factory filled with lubricant only if supplied with an electric motor. Otherwise, the speed variator is supplied unlubricated and the customer is responsible for filling it prior to putting the unit into service. In this case, the motor shaft must be fitted with an oil seal and the mounting flange must be oil tight.

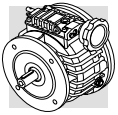

Breather plug



Filter plug



Drain plug



Level plug



90° elbow

V 0.25 - V 0.5

V 1 - V 2

B3

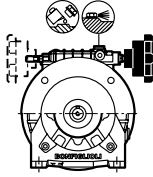

V 0.25 F	0.14	
V 0.5 F	0.18	
V 0.25 U_ / VR 0.25_	0.12	
V 0.5 U_ / VR 0.5_	0.15	
VD 0.5 U_ / VRD 0.5	0.30	

Oil Donax TX (for life)

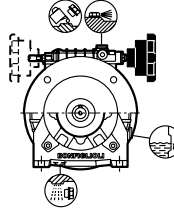

V 1 F	0.30	
V 2 F	0.40	
V 1 U_ / VR 1_	0.25	
V 2 U_ / VR 2_	0.32	
VD 1 U_ / VRD 1	0.35	
VD 2 U_ / VRD 2	0.46	

Oil Donax TA (2000-3000 hrs.)

B6

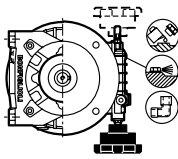

V 0.25 F	0.14	
V 0.5 F	0.18	
V 0.25 U_ / VR 0.25_	0.12	
V 0.5 U_ / VR 0.5_	0.15	
VD 0.5 U_ / VRD 0.5	0.30	

Oil Donax TX (for life)

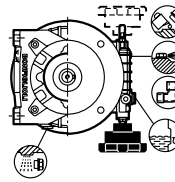

V 1 F	0.30	
V 2 F	0.40	
V 1 U_ / VR 1_	0.25	
V 2 U_ / VR 2_	0.32	
VD 1 U_ / VRD 1	0.35	
VD 2 U_ / VRD 2	0.46	

Oil Donax TA (2000-3000 hrs.)

B7

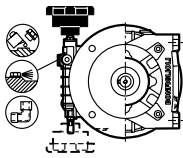

V 0.25 F	0.14	
V 0.5 F	0.18	
V 0.25 U_ / VR 0.25_	0.12	
V 0.5 U_ / VR 0.5_	0.15	
VD 0.5 U_ / VRD 0.5	0.30	

Oil Donax TX (for life)

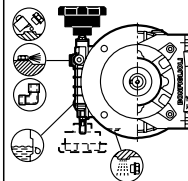

V 1 F	0.30	
V 2 F	0.40	
V 1 U_ / VR 1_	0.25	
V 2 U_ / VR 2_	0.32	
VD 1 U_ / VRD 1	0.35	
VD 2 U_ / VRD 2	0.46	

Oil Donax TA (2000-3000 hrs.)

B8

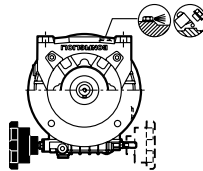

V 0.25 F	0.14	
V 0.5 F	0.18	
V 0.25 U_ / VR 0.25_	0.12	
V 0.5 U_ / VR 0.5_	0.15	
VD 0.5 U_ / VRD 0.5	0.30	

Oil Donax TX (for life)

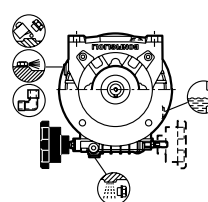

V 1 F	0.30	
V 2 F	0.40	
V 1 U_ / VR 1_	0.25	
V 2 U_ / VR 2_	0.32	
VD 1 U_ / VRD 1	0.35	
VD 2 U_ / VRD 2	0.46	

Oil Donax TA (2000-3000 hrs.)

V5

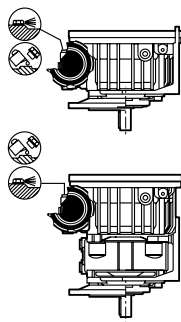

V 0.25 F	0.28	
V 0.5 F	0.30	
V 0.25 U_ / VR 0.25_	0.22	
V 0.5 U_ / VR 0.5_	0.27	

Oil Donax TX (for life)

VD 0.5 U_ / VRD 0.5	0.70	
---------------------	------	--

Oil Donax TX (for life)

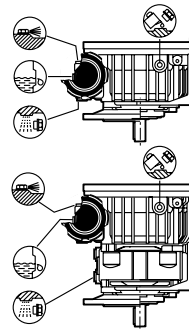

V 1 F	0.58	
V 2 F	0.78	
V 1 U_ / VR 1_	0.40	
V 2 U_ / VR 2_	0.54	

Oil Donax TA (2000-3000 hrs.)

VD 1 U_ / VRD 1	1.00	
VD 2 U_ / VRD 2	1.5	

Oil Donax TA (for life)

V6

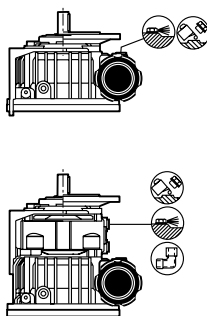

V 0.25 F	0.14	
V 0.5 F	0.18	
V 0.25 U_ / VR 0.25_	0.12	
V 0.5 U_ / VR 0.5_	0.15	

Oil Donax TX (for life)

VD 0.5 U_ / VRD 0.5	0.40	
---------------------	------	--

Oil Donax TX (for life)

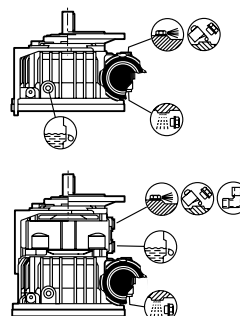

V 1 F	0.30	
V 2 F	0.40	
V 1 U_ / VR 1_	0.25	
V 2 U_ / VR 2_	0.32	

Oil Donax TA (2000-3000 hrs.)

VD 1 U_ / VRD 1	0.50	
VD 2 U_ / VRD 2	0.70	

Oil Donax TA (for life)

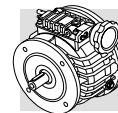
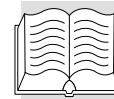

V 3 - V 5.5

V 10

B3

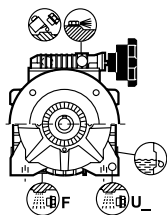

V 3 F - V 5.5 F_	0.70
V 3 U_ / VR 3 V 5.5 U_ / VR 5.5	1.0
VD 3 F VD 5.5 F_	1.3
VD 3 U_ / VRD 3 U VD 5.5 U_ / VRD 5.5 U_	1.6

Oil Donax TA (2000-3000 hrs.)

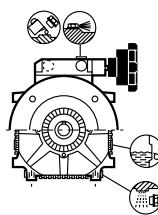

V 10 F V 10 U_ / VR 10	1.8
VD 10 F VD 10 U_ / VRD 10 U_	2.0

Oil Donax TA (2000-3000 hrs.)



B6

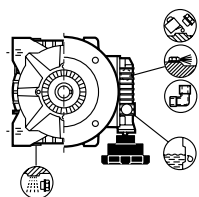

V 3 F - V 5.5 F_	0.90
V 3 U_ / VR 3 V 5.5 U_ / VR 5.5	1.0
VD 3 F VD 5.5 F_	1.3
VD 3 U_ / VRD 3 U VD 5.5 U_ / VRD 5.5 U_	1.6

Oil Donax TA (2000-3000 hrs.)

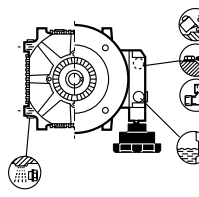

V 10 F V 10 U_ / VR 10	1.8
VD 10 F VD 10 U_ / VRD 10 U_	2.0

Oil Donax TA (2000-3000 hrs.)



B7

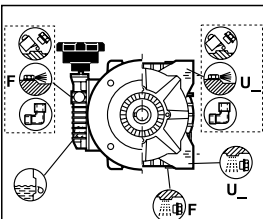

V 3 F - V 5.5 F_	0.90
V 3 U_ / VR 3 V 5.5 U_ / VR 5.5	1.0
VD 3 F VD 5.5 F_	1.3
VD 3 U_ / VRD 3 U VD 5.5 U_ / VRD 5.5 U_	1.6

Oil Donax TA (2000-3000 hrs.)

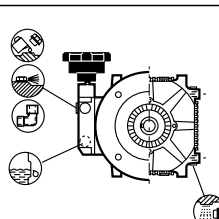

V 10 F V 10 U_ / VR 10	1.8
VD 10 F VD 10 U_ / VRD 10 U_	2.0

Oil Donax TA (2000-3000 hrs.)



B8

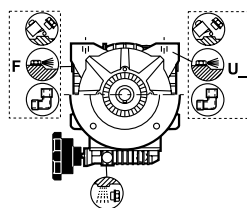

V 3 F - V 5.5 F_	1.0
V 3 U_ / VR 3 V 5.5 U_ / VR 5.5	1.3
VD 3 F VD 5.5 F_	1.6
VD 3 U_ / VRD 3 U VD 5.5 U_ / VRD 5.5 U_	1.9

Oil Donax TA (2000-3000 hrs.)

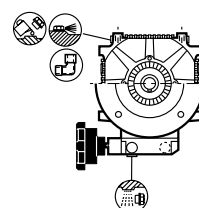

V 10 F V 10 U_ / VR 10	2.1
VD 10 F VD 10 U_ / VRD 10 U_	2.1

Oil Donax TA (2000-3000 hrs.)



V5

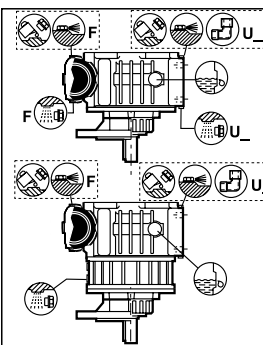

V 3 F - V 5.5 F_	2.1
V 3 U_ / VR 3 V 5.5 U_ / VR 5.5	2.0

Oil Donax TA (2000-3000 hrs.)

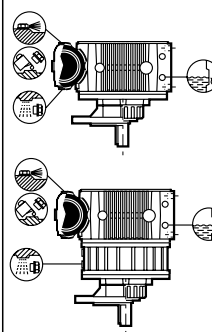

V 10 F V 10 U_ / VR 10	3.2
---------------------------	-----

Oil Donax TA (2000-3000 hrs.)



VD 3 F VD 5.5 F_	4.5
VD 3 U_ / VRD 3 U VD 5.5 U_ / VRD 5.5 U_	4.8

Oil Donax TA (2000-3000 hrs.)



VD 10 F VD 10 U_ / VRD 10	8.5
------------------------------	-----

Oil Donax TA (2000-3000 hrs.)



V6

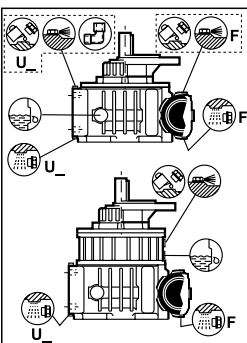

V 3 F - V 5.5 F_	1.0
V 3 U_ / VR 3 V 5.5 U_ / VR 5.5	1.3

Oil Donax TA (2000-3000 hrs.)

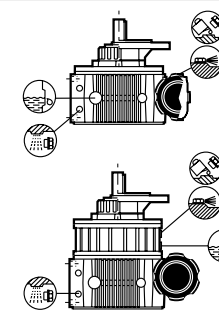

V 10 F V 10 U_ / VR 10	2.8
---------------------------	-----

Oil Donax TA (2000-3000 hrs.)



VD 3 F VD 5.5 F_	2.8
VD 3 U_ / VRD 3 U VD 5.5 U_ / VRD 5.5 U_	3.0

Oil Donax TA (2000-3000 hrs.)



VD 10 F VD 10 U_ / VRD 10	7.0
------------------------------	-----

Oil Donax TA (2000-3000 hrs.)



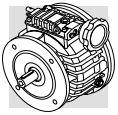

8.3 - REPLACING THE OIL – Speed variators V1 to V10

1. Place an adequate container under the drain plug.
2. Remove the filler, drain and level caps and allow the oil to drain out.



The oil will drain better if it is warm.

3. Wait a few minutes until all the oil has drained out and then screw back on the drain cap only after first fitting it with a new gasket.
4. Orient the speed variator in its final position and fill with oil. Pour the oil slowly to ensure even filling. Stop filling when the oil is flush with the level cap. Screw on the level cap after first fitting a new gasket and continue filling to its midline point.
5. Tighten down the filler cap after changing its gasket.



The speed variator may be supplied with or without lubricant, as requested by the user. The quantity of charge oil required is specified in the Sales Catalogue. Note, however, that this quantity is approximate only and the unit must in any case be filled to the midline point of the level cap.



Lubricants, solvents and detergents are toxic/harmful to health:

- they may cause irritation in direct contact with the skin
- they may cause intoxication if inhaled
- they may be fatal if swallowed.

Handle them with care using suitable individual safety equipment. Do not dump them into the environment and dispose of in observance of applicable legislation.



If a leak is found, identify the cause of the fault and repair it before topping up the lubricant and operating the speed variator.

8.4 - RECOMMENDED LUBRICANTS

		V		VR
		0.25-0.5	1 ... 10	0.25 ... 10
	Donax TX	R	-	
	Donax TA	-	R	
	Cassida Fluid HF 46	F	F	
	TVX Compound B	-	-	G

Legend:

- R** Recommended
- F** Food grade
- G** Grease

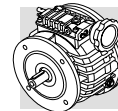
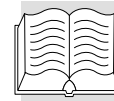

8.5 - CHECKING EFFICIENCY

- Remove dust deposits from the speed variator and motor casings.
- Check that the noise generated at constant load does not vary. Excessive vibration or noise may indicate wear of the satellite discs or failure of a bearing.
- Check the power absorption and voltage against the nominal values given on the motor's nameplate.
- Check for lubricant leaks from the gaskets/seals, caps and casings.
- Check all bolted couplings for wear, deformation and corrosion and tighten them down fully without over tightening.

8.6 - CLEANING

Remove all dust and process waste from the speed variator. Do not use solvents or other products which are incompatible with the construction material and do not direct high pressure jets of water at the speed variator.

8.7 - PAINT COATING

V 0.25 speed variators feature an aluminium casing and are not paint coated.

V 0.5 to V 10 variators have cast-iron casings which are coated with polyester heat-setting resin which is then baked on.



If the speed variator is to be paint coated, protect the nameplate and seal rings against contact with the solvent.

9.0 - REPLACING PARTS



- Do not hesitate to replace parts and components if they are not able to guarantee safe and reliable operation.
- Never improvise repairs.
- The use of non-original spare parts not only voids the warranty but can compromise variator operation.

9.1 - DECOMMISSIONING THE SPEED VARIATOR

The speed variator must only be taken out of service by operators trained in the observance of applicable laws on health and safety at work.

Do not dump non-biodegradable products, lubricants and non-ferrous materials (rubber, PVC, resins, etc.) into the environment. Dispose of all such materials as stipulated by established environmental legislation.



Do not re-use parts or components which appear to be in good condition after they have been checked or replaced by qualified personnel and declared unsuitable for use.

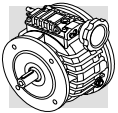

9.2 - REMOVING THE ELECTRIC MOTOR

If during operation the coupling between the motor and speed variator has not fret corroded significantly, it should be possible to remove the motor without applying excessive force.

If, on the other hand, it proves difficult to remove the motor, do not use screwdrivers or levers to apply force as this may damage the flanges and coupling surfaces, but proceed as shown below.

(A3)

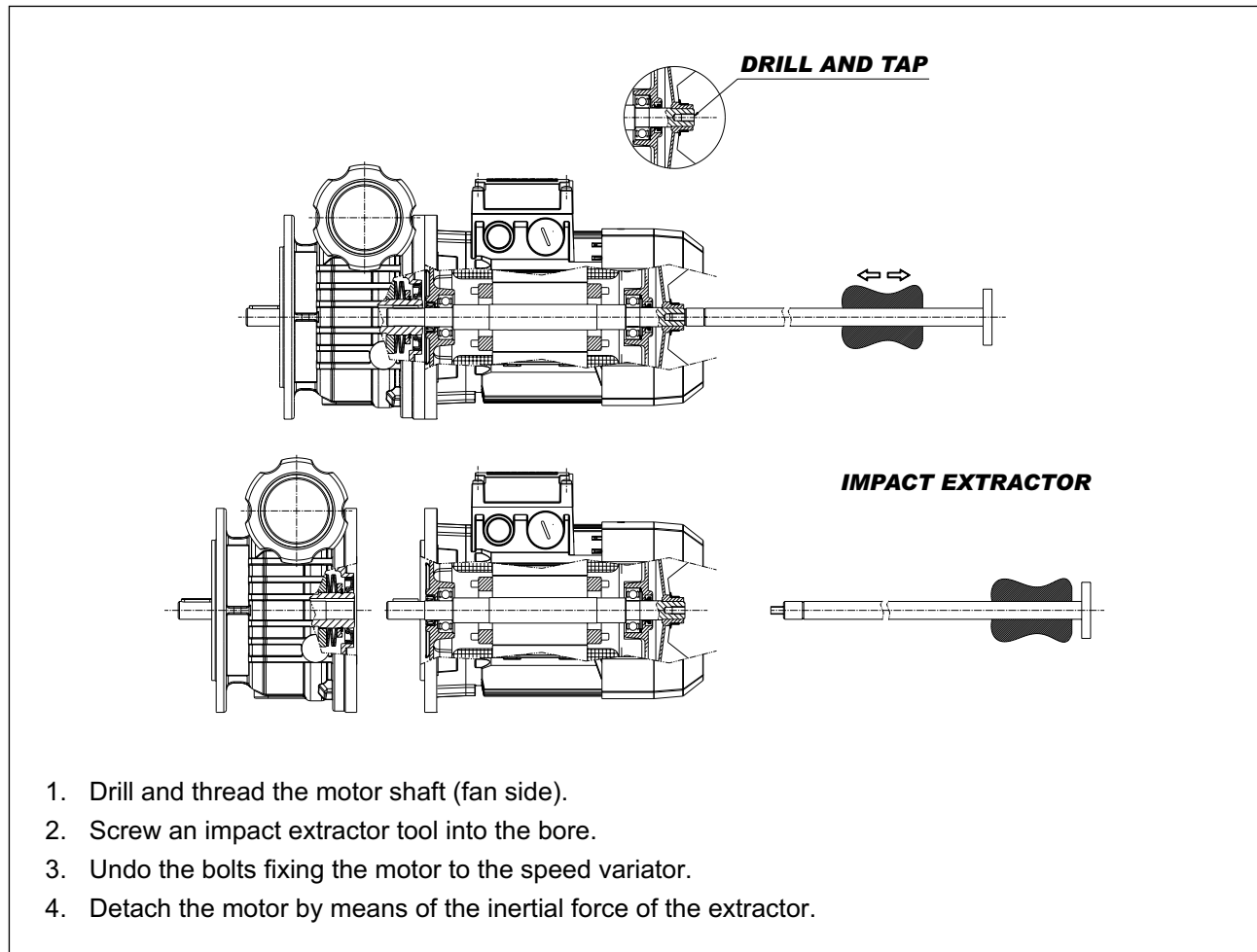

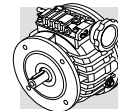
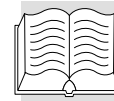

10.0 - TROUBLESHOOTING

The following information is intended to serve as an aid in identifying and eliminating defects and faults. In some cases, such problems may be caused by the plant or machine to which the speed variator is assembled, and hence the cause and eventual solution will be found in the Manufacturer's technical documentation for the machine/plant in question.

PROBLEM	CAUSE	SOLUTION
Bearing temperature too high	Oil level too low	Top up oil level
	Oil spent	Replace oil
	Defective bearings	Contact authorised workshop
Operating temperature too high	Oil level too high	Check oil level
	Oil spent	Replace oil
	Contaminant in oil	Replace oil
Abnormal running noise	Satellite discs damaged	Contact authorised workshop
	Bearing axial backlash too high	Contact authorised workshop
	Bearings defective or worn	Contact authorised workshop
	Excessive load is applied	Correct load to rated values given in Sales Catalogue
	Contaminant in oil	Replace oil
Abnormal noise at variator mounting	Mounting bolts loose	Tighten bolts to specified torque
	Mounting bolts worn	Replace bolts
Oil leaks	Oil level too high	Check oil level
	Casing/coupling seal inadequate	Contact authorised workshop
	Gaskets worn	Contact authorised workshop
Speed variator does not run or runs with difficulty	Oil viscosity too high	Replace oil (see recommended lubricant chart)
	Oil level too high	Check oil level
	Excessive load is applied	Redesign drive for actual load required
Output shaft does not turn with motor running	Satellite discs damaged	Contact authorised workshop

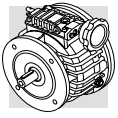

INDEX OF REVISIONS (R)

R0

We reserve the right to implement modifications without notice.
This catalogue cannot be reproduced, even partially, without prior consent.

**SEDE CENTRALE - HEADQUARTERS****BONFIGLIOLI RIDUTTORI S.p.A.**

Via Giovanni XXIII, 7/A
40012 Lippo di Calderara di Reno - Bologna (ITALY)
Tel. (+39) 051 6473111
Fax (+39) 051 6473126
www.bonfiglioli.com
bonfiglioli@bonfiglioli.com

SALES DEPARTMENT**INDUSTRIAL SOLUTIONS****BONFIGLIOLI RIDUTTORI S.p.A.**

Via Giovanni XXIII, 7/A
40012 Lippo di Calderara di Reno - Bologna (ITALY)
Tel. (+39) 051 6473111 - Fax (+39) 051 6473126
bonfiglioli@bonfiglioli.com

SALES DEPARTMENT**MOBILE SOLUTIONS****BONFIGLIOLI RIDUTTORI S.p.A.**

Via Enrico Mattei, 12 - Z.I. Villa Selva - 47100 Forlì (ITALY)
Tel. (+39) 0543 789111
Fax (+39) 0543 789242 - 0543 789245
trasmital@bonfiglioli.com

UFFICI VENDITE ITALIA - ITALY SALES OFFICES

PARMA - Largo Luca Ganzi, 9/E
Tel. 0521 987275 - Fax 0521 987368

DEPOSITI IN ITALIA - STOCK HOUSES IN ITALY**ASSAGO (MILANO)**

Via Idiomi ang. Donizetti
Tel. 02 48844710 / 02 4883395 - Fax 02 48844750 / 02 4883874

TORINO - Corso Susa, 242 - Palazzo Prisma 88 - 10098 Rivoli
Tel. 011 9585116 - Fax 011 9587503

MILANO - Via Idiomi ang. Donizetti - 20094 Assago - Milano
Tel. 0245716930 - Fax 0245712745

PADOVA - IX Strada, 1 - Zona Industriale
Tel. 049 8070911 - Fax 049 8074033 / 049 8073883

BONFIGLIOLI WORLDWIDE & BEST PARTNERS**AUSTRALIA**

BONFIGLIOLI TRANSMISSION (Aust) Pty Ltd.
48-50 Adderley St. (East) - Auburn (Sydney) N.S.W. 2144
Tel. (+61) 2 8748 4400 - Fax (+61) 2 9748 8740
P.o. Box 6705 Silverwater NSW 1811
www.bonfiglioli.com.au - bta1@bonfiglioli.com.au

BELGIUM *BEST*

N.V. ESCO TRANSMISSION S.A.
Culliganlaan 3 - 1831 Machelem Diegem
Tel. 0032 2 7204880 - Fax 0032 2 7212827 - Tlx 21930 Escopo B
www.escotrans.be - info@escotrans.be

CANADA

BONFIGLIOLI CANADA INC.
2-7941 Jane Street - Concord, ONTARIO L4K 4L6
Tel. (+1) 905 7384466 - Fax (+1) 905 7389833
www.bonfigliolicanada.com - sales@bonfigliolicanada.com

CHINA

BONFIGLIOLI DRIVES (SHANGHAI) CO. LTD.
No. 8 Building, Area C1 - 318, SuHong Road, Qingpu
Shanghai 201700
Tel. +86 21 59228800 - Fax +86 21 59228811
www.bonfiglioli.cn - linkn@bonfiglioli.com

GREAT BRITAIN

BONFIGLIOLI UK Ltd
Unit 3 Colemeadow Road - North Moons Moat
Redditch. Worcestershire B98 9PB
Tel. (+44) 1527 65022 - Fax (+44) 1527 61995
www.bonfiglioli.co.uk - marwaha@bonfiglioli.com

FRANCE

BONFIGLIOLI TRANSMISSIONS S.A.
14 Rue Eugène Pottier BP 19
Zone Industrielle de Moimont II - 95670 Marly la Ville
Tel. (+33) 1 34474510 - Fax (+33) 1 34688800
www.bonfiglioli.fr - btf@bonfiglioli.fr

GERMANY

BONFIGLIOLI GETRIEBE GmbH
Hamburger Straße 18 - 41540 Dormagen
Tel. (+49) 2133 50260 - Fax (+49) 2133 502610
www.bonfiglioli.de - bonfiglioli.getriebe@bonfiglioli.de

VECTRON Elektronik GmbH

Europark Fichtenhain A 6 47807 Krefeld
Tel. (+49) 2151 83960 - Fax (+49) 2151 839699
www.vectron.net - info@vectron.net

GREECE

BONFIGLIOLI HELLAS S.A.
O.T. 48A T.O. 230 - C.P. 570 22, Industrial Area - Thessaloniki
Tel. (+30) 2310 796456 - Fax (+30) 2310 795903
www.bonfiglioli.gr - bonfigr@otenet.gr

HOLLAND *BEST*

ELSTO AANDRIJFTECHNIEK
Loosterweg, 7 - 2215 TL Voorhout
Tel. (+31) 252 219 123 - Fax (+31) 252 231 660
www.elsto.nl - imfo@elsto.nl

HUNGARY *BEST*

AGISYS AGITATORS & TRANSMISSIONS Ltd
2045 Törökbálint, Tó u.2. Hungary
Tel. +36 23 50 11 50 - Fax +36 23 50 11 59
www.agisys.hu - info@agisys.com

INDIA

BONFIGLIOLI TRANSMISSIONS PVT Ltd.
PLOT AC7-AC11 Sidco Industrial Estate
Thirumudivakkam - Chennai 600 044
Tel. +91(0)44 24781035 / 24781036 / 24781037
Fax +91(0)44 24780091 / 24781904
www.bonfiglioli.co.in - bonfig@vsnl.com

NEW ZEALAND *BEST*

SAECO BEARINGS TRANSMISSION
36 Hastie Avenue, Mangere - Po Box 22256, Otahuhu - Auckland
Tel. +64 9 634 7540 - Fax +64 9 634 7552 - mark@saeco.co.nz

POLAND *BEST*

POLPACK Sp. z o.o. - Ul. Chrobrego 135/137 - 87100 Torun
Tel. 0048.56.6559235 - 6559236 - Fax 0048.56.6559238
www.polpack.com.pl - polpack@polpack.com.pl

RUSSIA *BEST*

FAM
57, Maly prospekt, V.O. - 199048, St. Petersburg
Tel. +7 812 3319333 - Fax +7 812 3271454
www.fam-drive.ru - fam@nm.ru

SPAIN

TECNOTRANS SABRE S.A.
Pol. Ind. Zona Franca sector C, calle F, n°6 08040 Barcelona
Tel. (+34) 93 4478400 - Fax (+34) 93 3360402
www.tecnotrans.com - tecnotrans@tecnotrans.com

SOUTH AFRICA

BONFIGLIOLI POWER TRANSMISSION Pty Ltd.
55 Galaxy Avenue, Linbro Business Park - Sandton
Tel. (+27) 11 608 2030 OR - Fax (+27) 11 608 2631
www.bonfiglioli.co.za - bonfigsales@bonfiglioli.co.za

SWEDEN

BONFIGLIOLI SKANDINAVIEN AB
Kontorsgatan - 234 34 Lomma
Tel. (+46) 40 412545 - Fax (+46) 40 414508
www.bonfiglioli.se - info@bonfiglioli.se

THAILAND *BEST*

K.P.T MACHINERY (1993) CO.LTD.
259/83 Soi Phiboonves, Sukhumvit 71 Rd. Phrakhanong-nur,
Wattana, Bangkok 10110
Tel. 0066.2.3913030/711998 - Fax 0066.2.7112852/3811308/3814905
www.kpt-group.com - sales@kpt-group.com

USA

BONFIGLIOLI USA INC
1000 Worldwide Boulevard - Hebron, KY 41048
Tel.: (+1) 859 334 3333 - Fax: (+1) 859 334 8888
www.bonfiglioliusa.com
industrialsales@bonfiglioliusa.com - mobilesales@bonfiglioliusa.com

VENEZUELA *BEST*

MAQUINARIA Y ACCESORIOS IND. C.A.
Calle 3B - Edif. Comindu - Planta Baja - Local B
La Urbina - Caracas 1070
Tel. 0058.212.2413570 / 2425268 / 2418263
Fax 0058.212.2424552 - Tlx 24780 Maica V
www.maica-ve.com - maica@telcel.net.ve

Distribuzione esclusiva ricambi Bonfiglioli / Spare parts Bonfiglioli



Via Castagnini, 2-4 - Z.I. Bargellino 40012 Calderara di Reno (BO) - Italy
Tel. 051.727844 - Fax 051.727066 - brt@bonfiglioli.com - www.brtonfiglioliricambi.it

Bonfiglioli Riduttori sceglie lubrificanti SHELL



Bonfiglioli Riduttori recommends SHELL lubricants

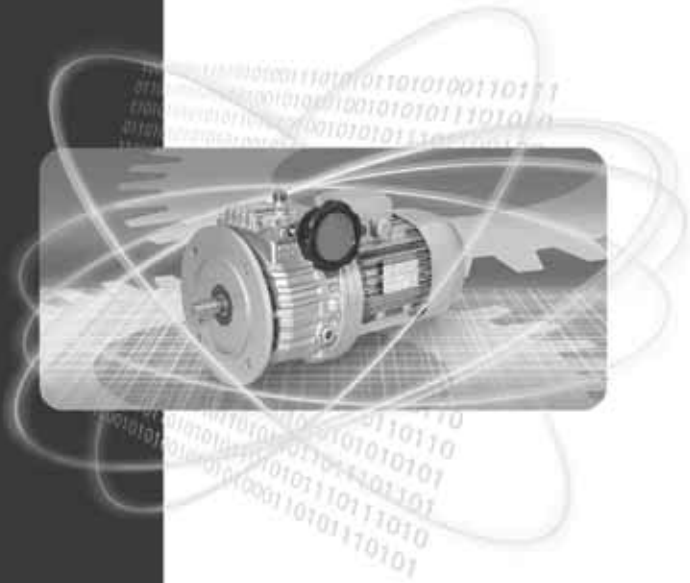

www.bonfiglioli.com

