

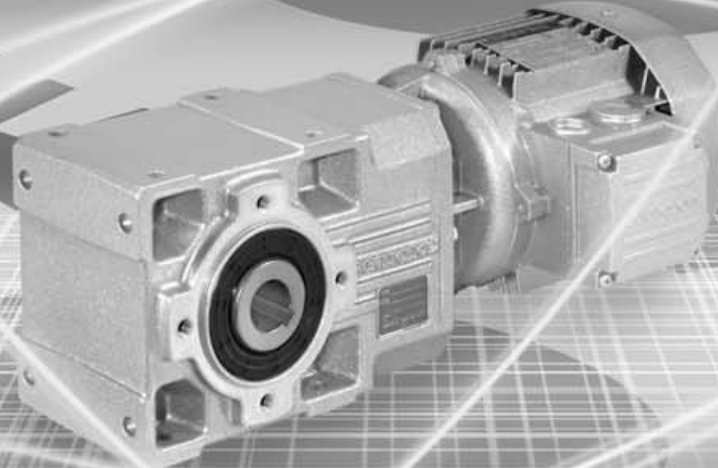





































































































































































































Lista parti di ricambio - Spare parts list - Ersatzteilliste
Liste des pieces detachees - Lista de partes de recambio

A



Quadro d'unione delle tavole parti di ricambio
Index of spare parts tables
Inhaltsverzeichnis Ersatzteillisten
Index des tables de pièces de rechange
Índice de la tabla de partes de recambio

	A 10 2	A 20 2	A 20 3	A 30 2	A 30 3	A 41 2	A 41 3	A 50 2	A 50 3	A 50 4
INPUT  S_	 2 +  16	 2 +  16	 2 +  12 +  16	 2 +  16	 2 +  12 +  16	 2 +  16	 4 +  16	 4 +  12 +  16	 4 +  12 +  16	 4 +  12 +  18
 P63 ... P132	 2 +  18	 2 +  18	 2 +  12 +  18	 2 +  18	 2 +  12 +  18	 2 +  18	 4 +  18	 4 +  12 +  18	 4 +  12 +  18	 4 +  12 +  22
 P160 ... P250	 2 +  22	 2 +  22	 2 +  12 +  22	 2 +  22	 2 +  12 +  22	 2 +  22	 4 +  20	 4 +  22	 4 +  22	 4 +  12 +  22
 HS	 2 +  22	 2 +  22	 2 +  12 +  22	 2 +  22	 2 +  12 +  22	 2 +  22	 4 +  20	 4 +  22	 4 +  22	 4 +  12 +  22

	A 60 2	A 60 3	A 60 4	A 70 3	A 70 4	A 80 3	A 80 4	A 90 3	A 90 4
INPUT  S_	 6 +  16	 6 +  16	 6 +  12 +  16	 8 +  16	 8 +  14 +  16	 10 +  16	 10 +  14 +  16	 10 +  14 +  16	 10 +  14 +  16
 P63 ... P132	 6 +  18	 6 +  18	 6 +  12 +  18	 8 +  18	 8 +  14 +  18	 10 +  18	 10 +  14 +  18	 10 +  14 +  18	 10 +  14 +  18
 P160 ... P250	 6 +  20	 6 +  20	 6 +  12 +  20	 8 +  20	 8 +  14 +  20	 10 +  20	 10 +  14 +  20	 10 +  14 +  20	 10 +  14 +  20
 HS	 6 +  24	 6 +  24	 6 +  12 +  24	 8 +  24	 8 +  14 +  24	 10 +  24	 10 +  14 +  24	 10 +  14 +  24	 10 +  14 +  24

A 10

A 20

A 30

A 41

Modulo uscita
Output sub-assembly
Abtriebseinheit
Module de sortie
Módulo de salida

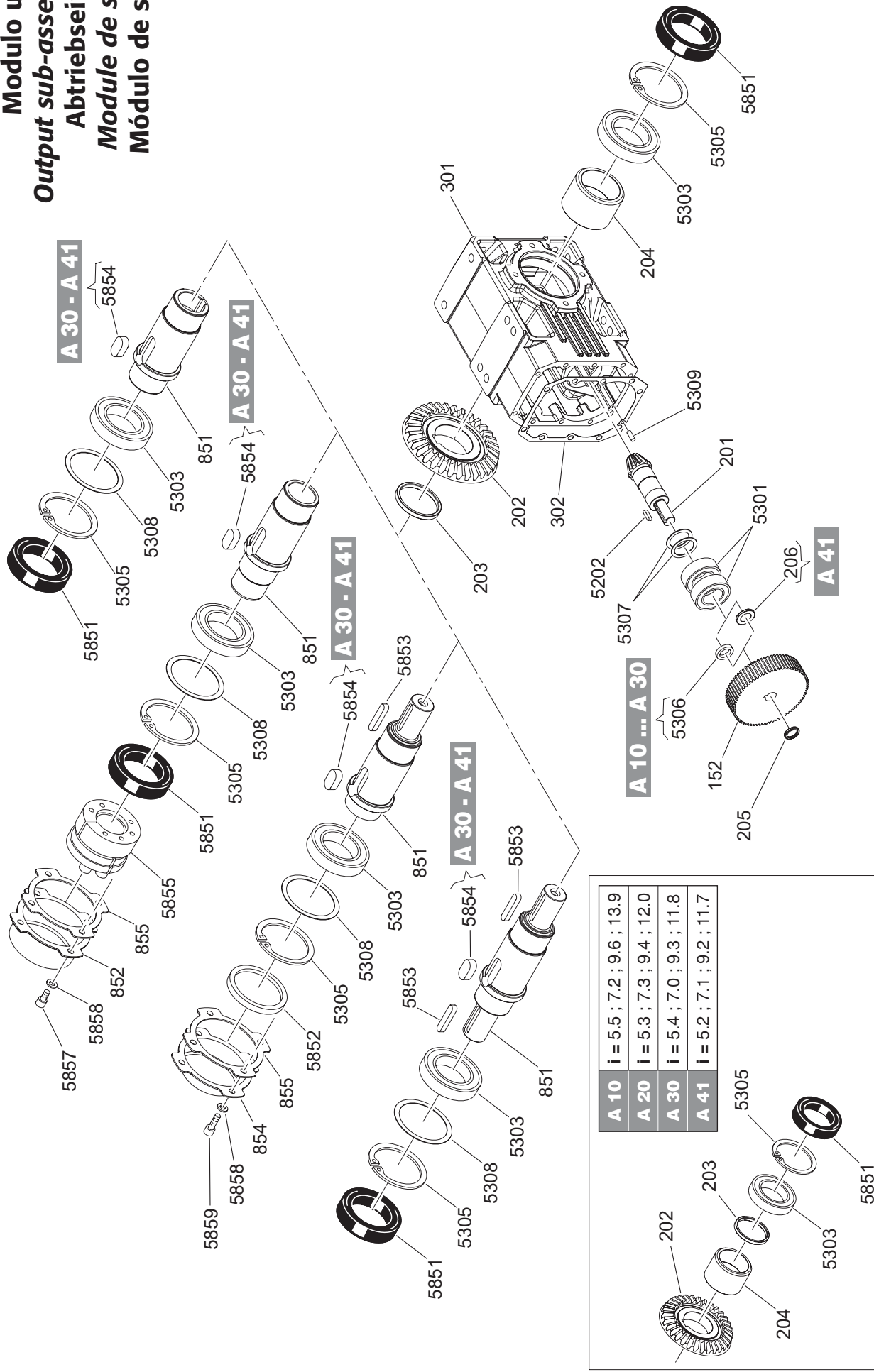

A 10	i = 5.5 ; 7.2 ; 9.6 ; 13.9
A 20	i = 5.3 ; 7.3 ; 9.4 ; 12.0
A 30	i = 5.4 ; 7.0 ; 9.3 ; 11.8
A 41	i = 5.2 ; 7.1 ; 9.2 ; 11.7



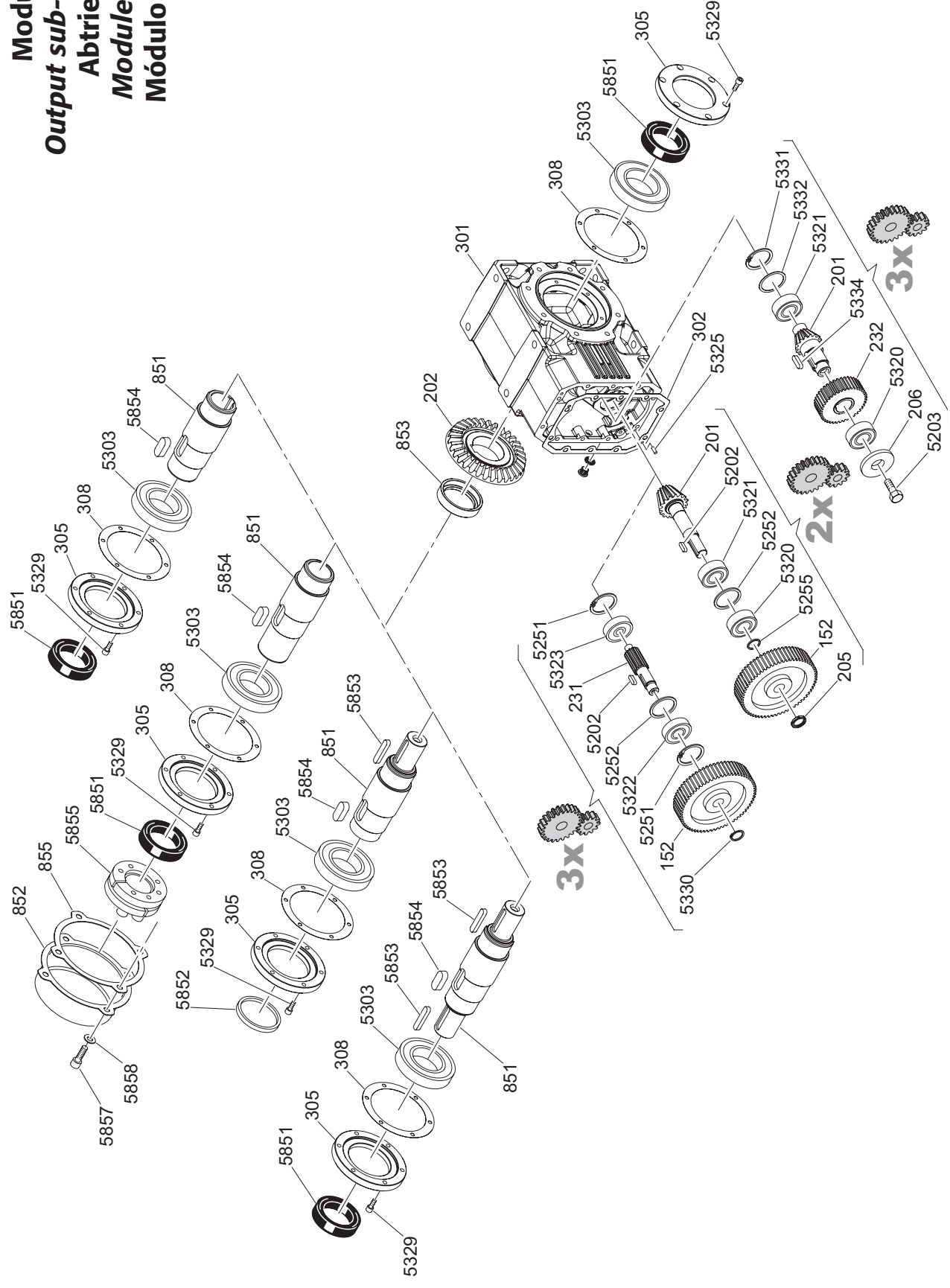

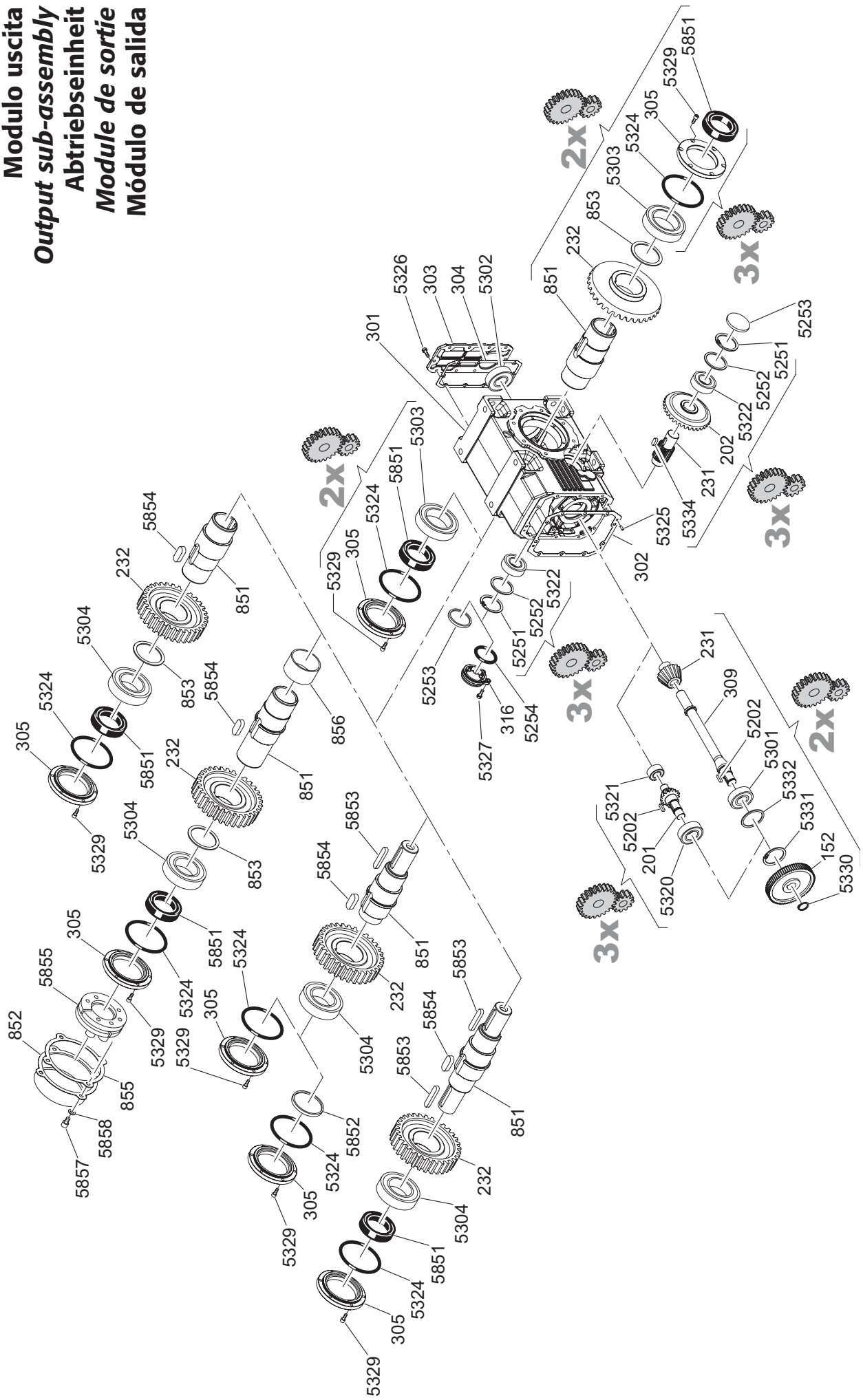

Modulo uscita
Output sub-assembly
Abtriebseinheit
Module de sortie
Módulo de salida









Modulo uscita
Output sub-assembly
Abtriebseinheit
Module de sortie
Módulo de salida



Pos.	Descrizione	Description	Benennung	Description	Descrizione
152	Corona	Gear	Zahnrad	Couronne	Corona
201	Pignone	Pinion gear	Ritzel	Pignon	Piñon
202	Corona	Gear	Zahnrad	Couronne	Corona
231	Pignone	Pinion gear	Ritzel	Pignon	Piñon
232	Corona	Gear	Zahnrad	Couronne	Corona
301	Cassa	Housing	Gehäuse	Carter	Caja
302	Guarnizione	Gasket	Dichtung	Joint plat	Junta
303	Coperchio	Cover	Deckel	Couvercle	Tapa
304	Guarnizione	Gasket	Dichtung	Joint plat	Junta
305	Flangia	Flange	Flansch	Bride	Brida
309	Albero	Shaft	Welle	Arbre	Eje
316	Cappello	Holder	Deckel	Capuchon	Sombrero
851	Albero lento	Output shaft	Abtriebswelle	Arbre de sortie	Eje de salida
852	Protezione	Safety cover	Schutzvorrichtung	Protection	Protección
855	Guarnizione	Gasket	Dichtung	Joint plat	Junta
856	Distanziale	Spacer ring	Distanzring	Entretoise	Distanciador





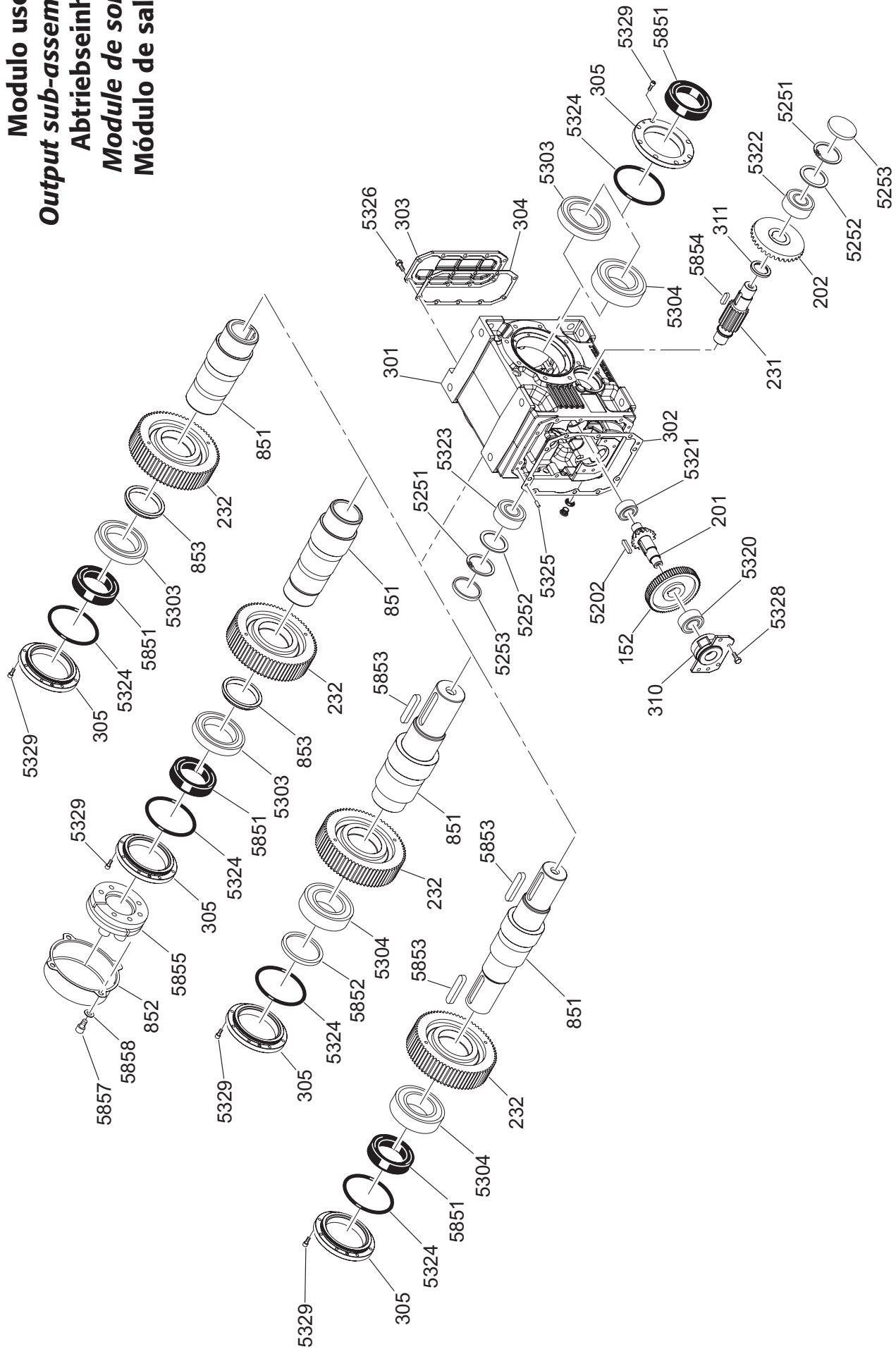

															
A 60 2	5301	5302	5303	5304	5320	5321	5322	5323	5330	5331	5332	5333	5352	5353	5355
	31307	31308	32018X	32216					De30	80			90x110x3.5 R	80x8	110x10
A 60 3			32018X	32216	32208	33205	32208		De30	80			90x110x3.5 R	80x8	110x10





													
A 60 2	5202	5334	5853	5854	5326	5327	5329	5857	5858	5851	5254	5324	5855
	8x7x30 B		18x11x90 A	25x14x60 B	T.E. M8x25	T.E. M8x25	T.C.E. M8x22	T.C.E. M12x20	ø13	90x110x12 DL 80x110x10 DL	75.87x2.62	133.02x2.62	CAL.19 D90 VTCEI 12
A 60 3	8x7x30 B	12x8x28 C	18x11x90 A	25x14x60 B	T.E. M8x25	T.E. M8x25	T.C.E. M8x22	T.C.E. M12x20	ø13	90x110x12 DL 80x110x10 DL	75.87x2.62	133.02x2.62	CAL.19 D90 VTCEI 12

Modulo uscita
Output sub-assembly
Abtriebseinheit
Module de sortie
Módulo de salida



Pos.	Descrizione	Description	Benennung	Description	Description
152	Corona	Gear	Zahnrad	Couronne	Corona
201	Pignone	Pinion gear	Ritzel	Pignon	Piñon
202	Corona	Gear	Zahnrad	Couronne	Corona
231	Pignone	Pinion gear	Ritzel	Pignon	Piñon
232	Corona	Gear	Zahnrad	Couronne	Corona
301	Cassa	Housing	Gehäuse	Carter	Caja
302	Guarnizione	Gasket	Dichtung	Joint plat	Junta
303	Coperchio	Cover	Deckel	Couvercle	Tapa
304	Guarnizione	Gasket	Dichtung	Joint plat	Junta
305	Cappello	Holder	Deckel	Capuchon	Sombrete
310	Supporto per cuscinetto	Bearing support	Lageraufnahme	Support roulement	Soporte para rodamiento
311	Distanziale	Spacer ring	Distanzring	Entretoise	Distanciadore
851	Albero lento	Output shaft	Abtriebswelle	Arbre de sortie	Eje de salida
852	Protezione	Safety cover	Schutzvorrichtung	Protection	Protección
853	Distanziale	Spacer ring	Distanzring	Entretoise	Distanciadore
931	Flangia	Flange	Flansch	Bride	Brida





												
	5303	5304	5320	5321	5322	5323	5251	5252	5325	5253	5852	5855
A 70	6021	32218	33207	33206	32308 B	32308	90	70x90x3.5	ø8x20	ø90x10	ø130x12	TLK 600.03 ø100

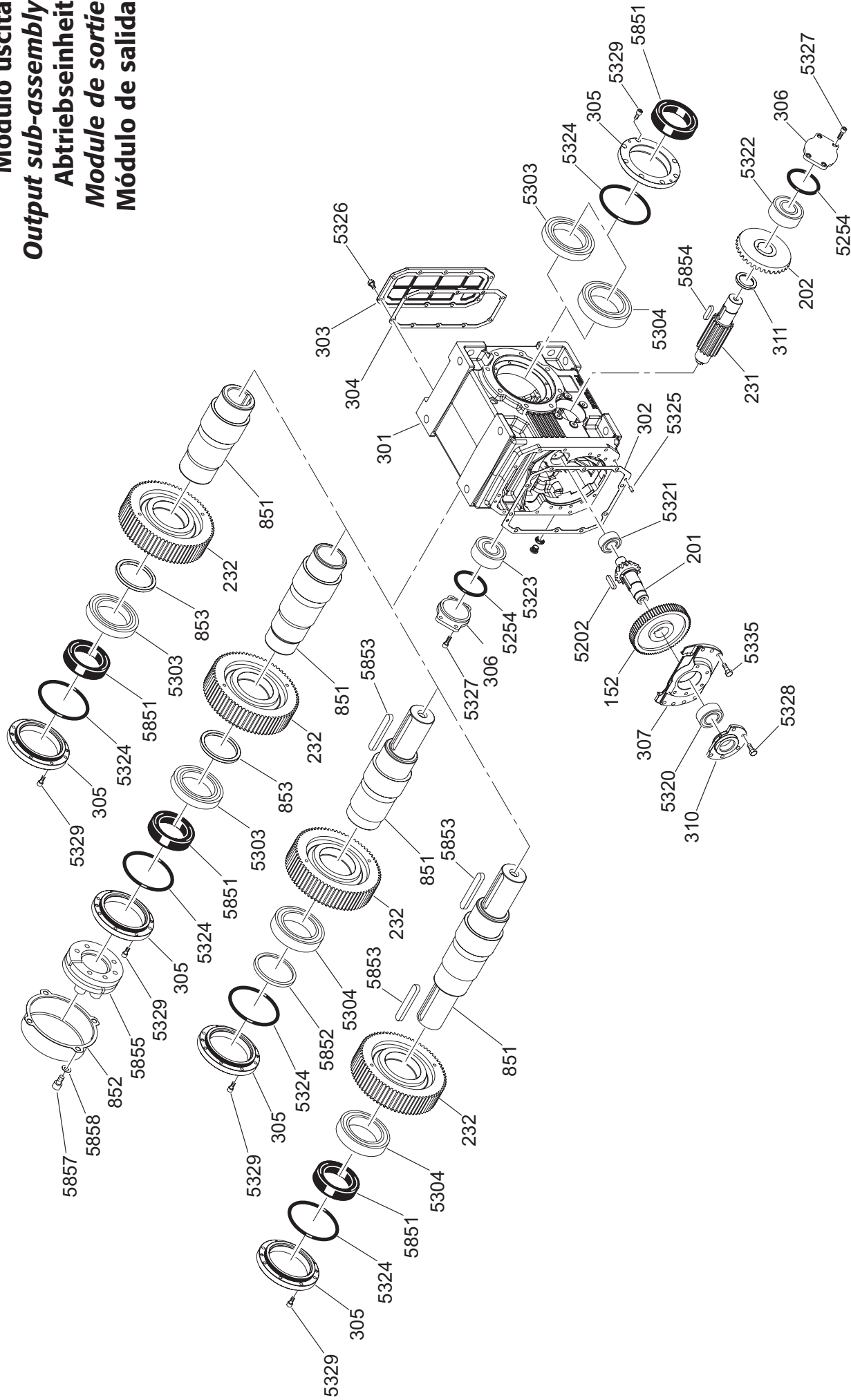



										
	5202	5853	5854	5326	5328	5329	5857	5858	5851	5324
A 70	12x8x45 "C"	22x14x110 "A"	14x9x41 "C"	T.E. M10x25	T.E. M10x25	T.C.E. M8x22	T.C.E. M14x25	ø15	105x130x12 "DL" 90x130x12 "DL"	4600

Modulo uscita
Output sub-assembly
Abtriebseinheit
Module de sortie
Módulo de salida

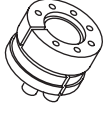

Pos.	Descrizione	Description	Benennung	Description	Description
152	Corona	Gear	Zahnrad	Couronne	Corona
201	Pignone	Pinion gear	Ritzel	Pignon	Piñon
202	Corona	Gear	Zahnrad	Couronne	Corona
231	Pignone	Pinion gear	Ritzel	Pignon	Piñon
232	Corona	Gear	Zahnrad	Couronne	Corona
301	Cassa	Housing	Gehäuse	Carter	Caja
302	Guarnizione	Gasket	Dichtung	Joint plat	Junta
303	Coperchio	Cover	Deckel	Couvercle	Tapa
304	Guarnizione	Gasket	Dichtung	Joint plat	Junta
305	Cappello	Holder	Deckel	Capuchon	Sombrete
306	Cappello	Holder	Deckel	Capuchon	Sombrete
307	Supporto per cuscinetto	Bearing support	Lageraufnahme	Support roulement	Soporte para rodamiento
310	Supporto per cuscinetto	Bearing support	Lageraufnahme	Support roulement	Soporte para rodamiento
311	Distanziale	Spacer ring	Distanzring	Entretoise	Distanciadore
851	Albero lento	Output shaft	Abtriebswelle	Arbre de sortie	Eje de salida
852	Protezione	Safety cover	Schutzvorrichtung	Protection	Protección
853	Distanziale	Spacer ring	Distanzring	Entretoise	Distanciadore

					
A 80	5303 5304 5320 5321 5322 5323	5325	5852	5853	5854
	6024 32024 32026 32310 32309	ø8x20	ø150x12	25x14x160 "A"	16x10x50 "C"
A 90	6026 32026 32310	ø12x30	ø170x12	28x16x190 "A"	18x11x60 "C"

					
A 80	5855	5326 5327 5328	5335	5857	5254 5324
	TLK 600.03 ø110	T.C.E.I. M10x25 T.E. M12x30 T.E. M12x30	T.E. M12x35	T.C.E. M16x30	4412 4675
A 90	TLK 600.03 ø125	T.E. M10x25 T.C.E.I. M10x25 T.E. M16x30	T.E. M16x40	T.E. M20x30	4487 4750

A 20 3

A 30 3

A 41 3

A 50 4

A 60 4

Modulo addizionale
Additional gear module
Zusätzliche Baueinheit
Module additionnel
Módulo adicional

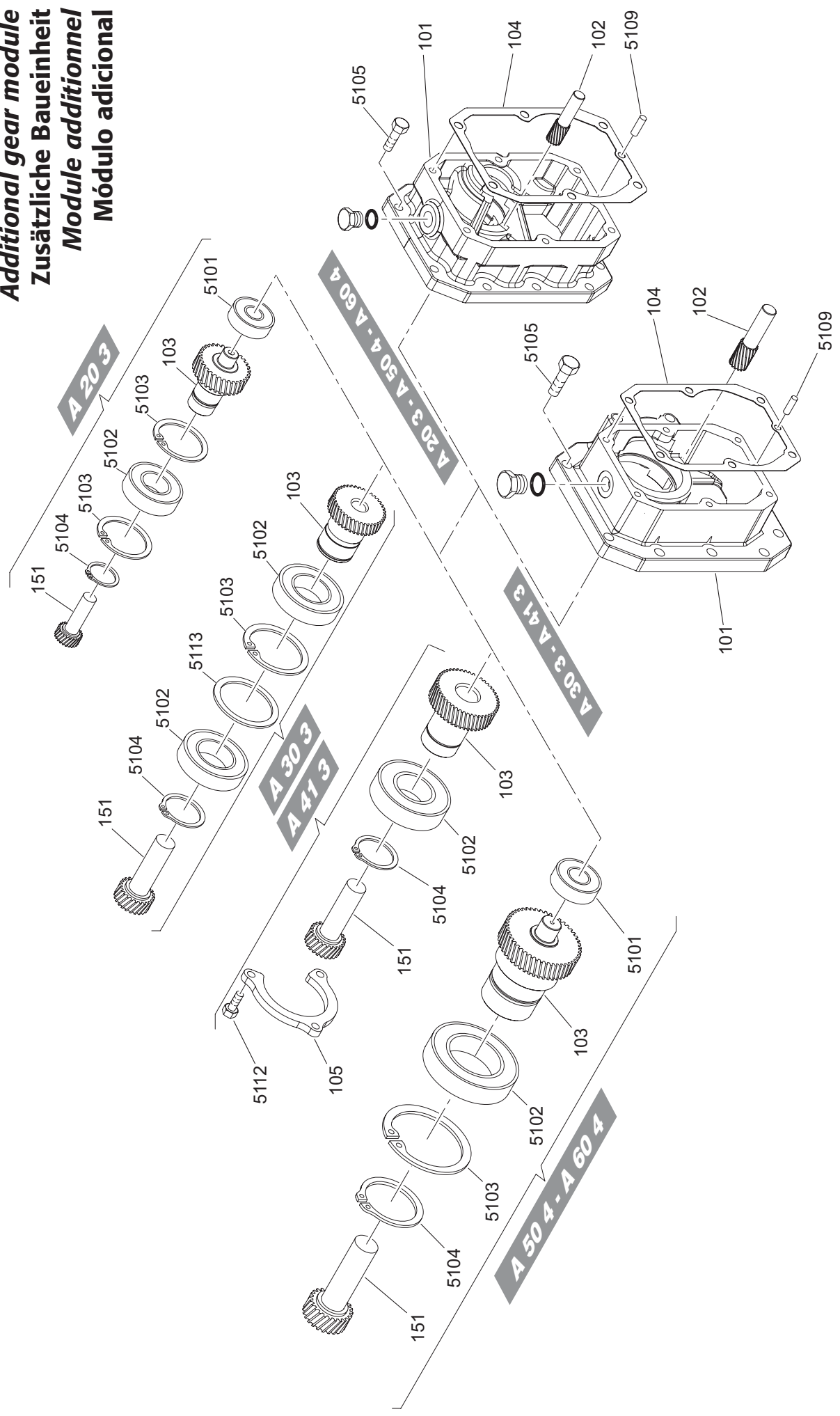



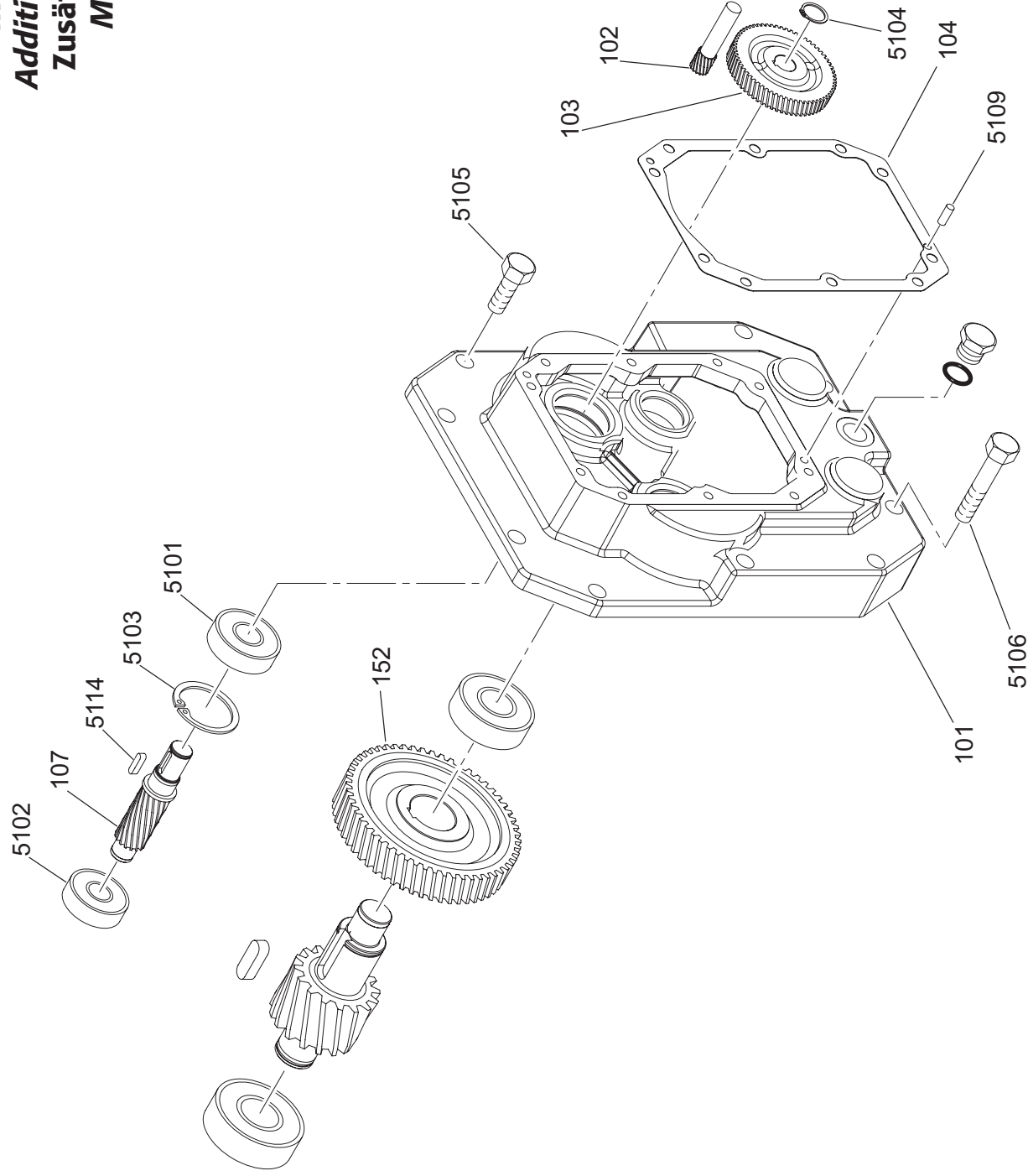

Pos.	Descrizione	Description	Benennung	Description	Description	Description
101	Modulo addizionale	<i>Additional gear module</i>	Zusätzliche Baueinheit	<i>Module additionnel</i>	Módulo adicional	
102	Pignone	<i>Pinion gear</i>	Ritzel	<i>Pignon</i>	Piñon	
103	Corona	<i>Gear</i>	Zahnrad	<i>Couronne</i>	Corona	
104	Guarnizione	<i>Gasket</i>	Dichtung	<i>Jointplat</i>	Junta	
105	Anello di battuta per cuscinetto	<i>Bearing retainer</i>	Schlußring	<i>Bague de fermeture</i>	Anillo de tope para rodamiento	
151	Pignone	<i>Pinion gear</i>	Ritzel	<i>Pignon</i>	Piñon	

	5101	5102	5104	5103	5109	5105	5112	5113
A 20 3	6201 2Z	6004	20	42	5x16	T.C.E. M6x20 T.C.E. M6x50		
A 30 3		6006	30	55	5x16	T.C.E. M8x25 T.C.E. M8x60		45x55x2 "R"
A 41 3		3206-2RS	30		5x16	T.E. M8x25 T.E. M8x65	T.E. M6x16	
A 50 4	NJ202	6008	40	68	6x16	T.E. M10x35 T.E. M10x75		
A 60 4	NJ203	6010	50	80	6x16	T.E. M10x35 T.E. M10x80		

Modulo addizionale
Additional gear module
Zusätzliche Baueinheit
Module additional
Módulo adicional





Pos.	Descrizione	Description	Benennung	Description	Description	Description
101	Modulo addizionale	Additional gear module	Zusätzliche Baueinheit	Module additionnel	Módulo adicional	
102	Pignone	Pinion gear	Ritzel	Pignon	Piñon	
103	Corona	Gear	Zahnrad	Couronne	Corona	
104	Guarnizione	Gasket	Dichtung	Jointplat	Junta	
107	Pignone	Pinion gear	Ritzel	Pignon	Piñon	
106	Supporto per cuscinetto	Bearing support	Lageraufnahme	Support roulement	Soporte para rodamiento	
411	Corona	Gear	Zahnrad	Couronne	Corona	

		5102		5105	5106	5115		5103	
A 70	6304	6303	5x5x19 C	T.E. M12x35	T.E. M12x65	T.C.E.I. M12x30 T.C.E.I. M12x40	17	52	8x26
A 80	6404	6304	6x6x25 C	T.E. M12x35	T.E. M12x65	T.C.E.I. M12x30	20	72	8x30
A 90	6306	6305	8x7x25 C	T.E. M16x50	T.E. M16x80	T.C.E.I. M16x35	25	72	6x16

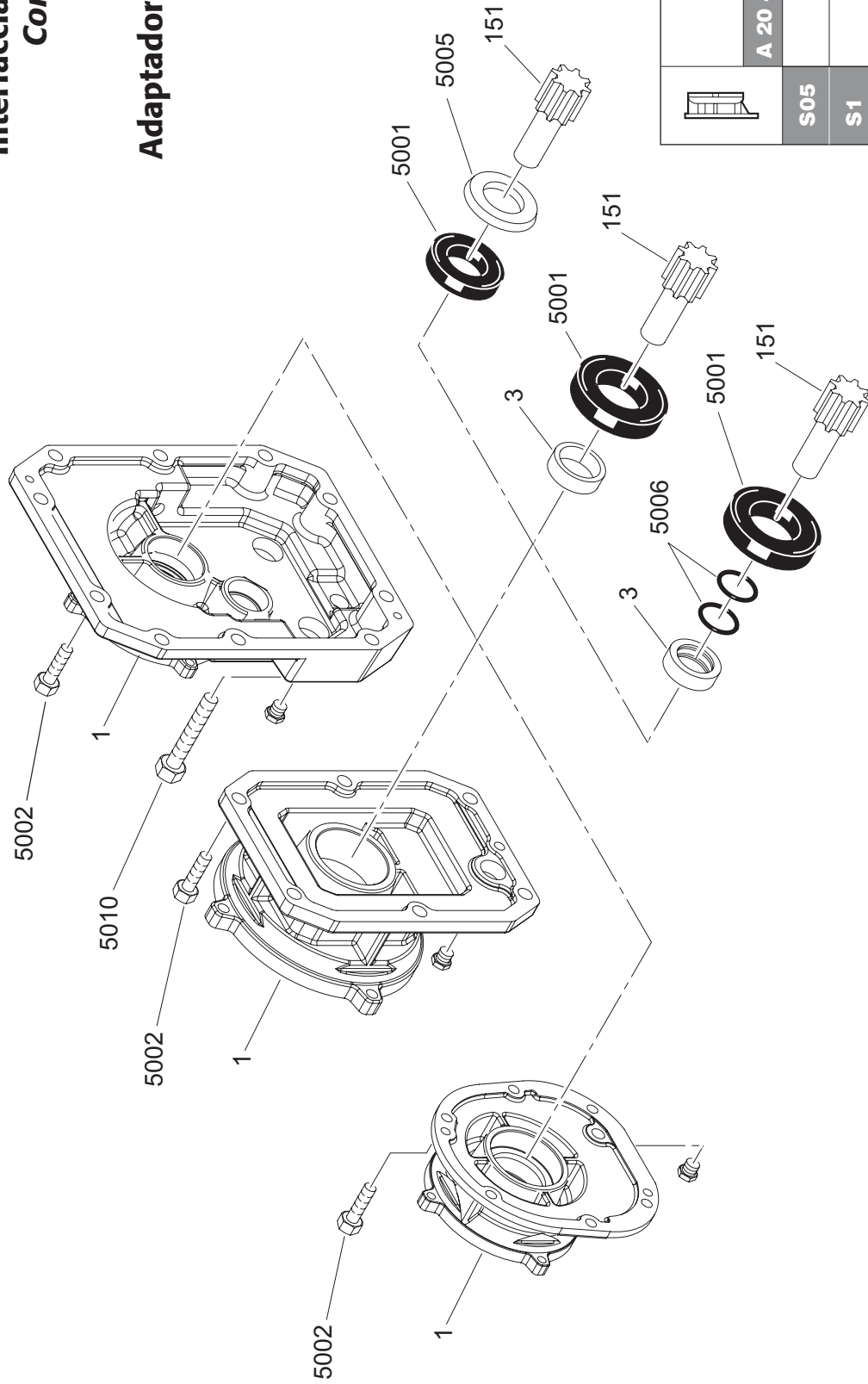
Interfaccia per motore compatto
Compact motor interface
S Baueinheit
Module S
Adaptador para motor compacto



	 OR 5006		
	A 20 - A 30	A 41 - A 50	A 60 ... A 90
S05			
S1			
S2			
S3	4137	4137	4137
S4		149	149
S5			149

Pos.	Descrizione	Description	Benennung	Description	Description
1	Coperchio	Cover	Deckel	Couvercle	Tapa
3	Boccola	Bushing	Buchse	Douille	Casquillo
151	Pignone	Pinion gear	Ritzel	Pignon	Piñon



	5001										5005			
	A 10	A 20	A 30	A 41 - A 50	A 60 - A 70	A 80 - A 90	A 10 - A 20	A 30	A 41 - A 50	A 60 - A 70	A 80 - A 90			
S05	20x35x7 L	20x35x7 L					20x35x4							
S1	20x35x7 L 25x35x7 L	20x35x7 L 25x35x7 L	20x35x7 L 25x35x7 L	20x35x7 L 25x35x7 L			20x35x4	20x35x4						
S2	35x55x8 L 42x55x8 L	35x55x8 L 42x55x8 L	35x55x8 L 42x55x8 L	35x55x8 L 42x55x8 L	35x55x8 L 42x55x8 L		35x52x4.5	35x52x4.5	35x52x4.5	35x52x4.5				
S3	35x62x7 L 48x62x8 L	35x62x7 L 48x62x8 L	35x62x7 L 48x62x8 L	35x62x7 L 48x62x8 L	35x62x7 L 48x62x8 L	35x62x7 L 48x62x8 L	35x52x4.5	35x52x4.5	35x52x4.5	35x52x4.5	35x52x4.5	35x52x4.5		
S4				45x85x10 L 65x85x10 L	45x85x10 L 65x85x10 L	45x85x10 L 65x85x10 L			45x62x4.5	45x62x4.5	45x62x4.5	45x62x4.5		
S5				45x85x10 L 65x85x10 L	45x85x10 L 65x85x10 L	45x85x10 L 65x85x10 L				45x62x4.5	45x62x4.5	45x62x4.5		

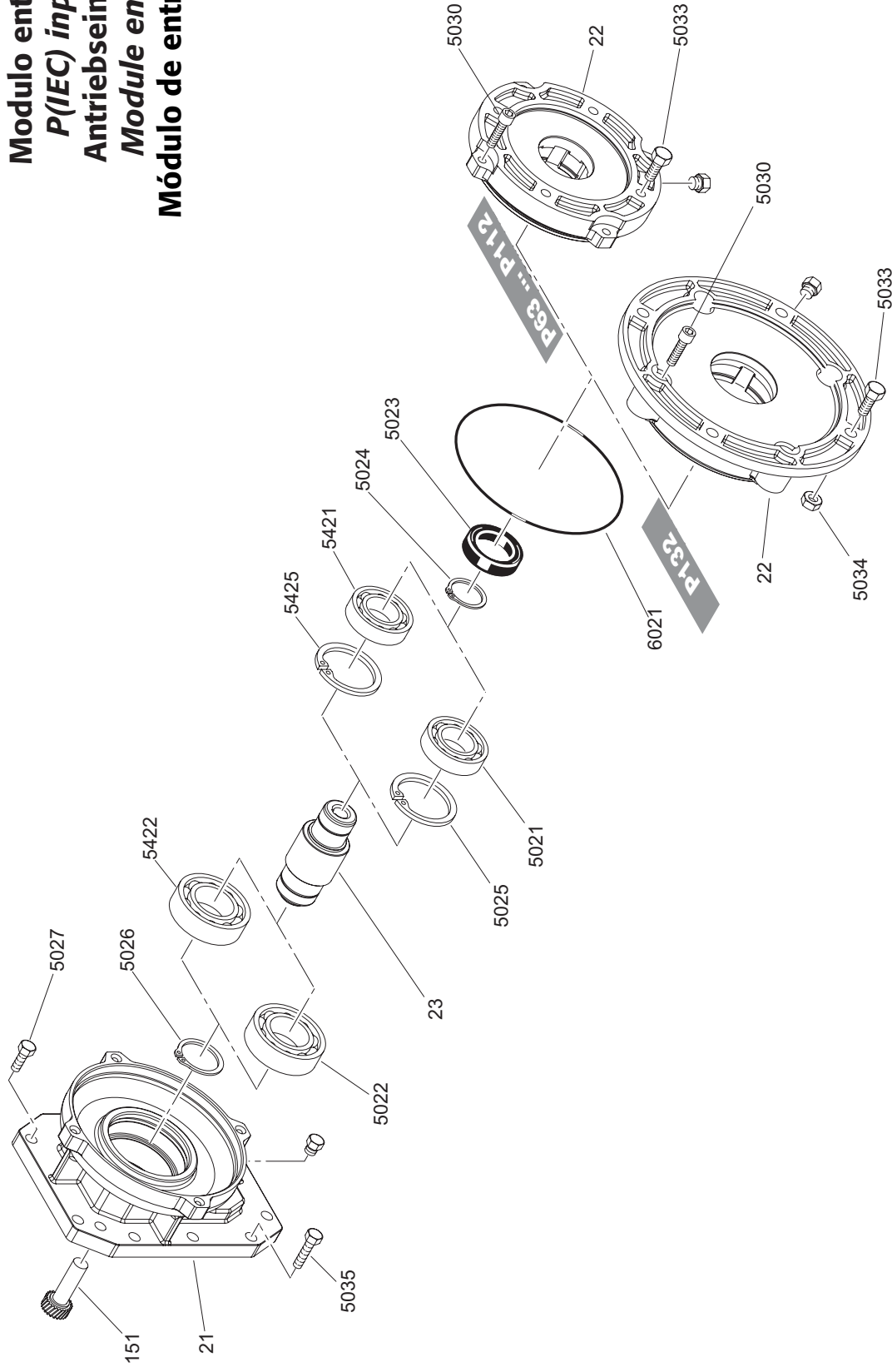

	5002										5010			
	A 10	A 20	A 30	A 41	A 50	A 60	A 70	A 80	A 90	A 70	A 80	A 90		
S05	M6x18 M6x20 M6x22	M6x20												
S1	M6x20 M6x22	M6x16 M6x18 M6x20 M6x22	M8x25	M8x25	M10x25 M10x30									
S2	M6x20 M6x22	M6x20 M6x22	M8x25	M8x20 M8x25	M10x25 M10x30	M10x30	M12x35			M12x65				
S3	M6x20 M6x22	M6x20 M6x22	M8x25	M8x20 M8x25	M10x25 M10x30	M10x30	M12x35	M12x35	M16x50	M12x65	M12x65	M16x80		
S4				M8x20 M8x25	M10x25 M10x30	M10x30	M12x35	M12x35	M16x50	M12x65	M12x65	M16x80		
S5						M10x30	M12x35	M12x35	M16x50	M12x65	M12x65	M12x80		

Modulo entrada P(IEC)
P(IEC) input module
Antriebseinheit P(IEC)
Module entree P(IEC)
Módulo de entrada P(IEC)



Pos.	Descrizione	Description	Benennung	Description	Description	Descrizione
21	Coperchio	Cover	Deckel	Couvercle	Tappe	Tappe
22	Flangia	Flange	Flansch	Bride	Brida	Brida
23	Albero veloce	Input shaft	Antriebswelle	Arbre rapide	eje de salida	eje de salida
151	Pignone	Pinion gear	Ritzel	Pignon	Piñon	Piñon





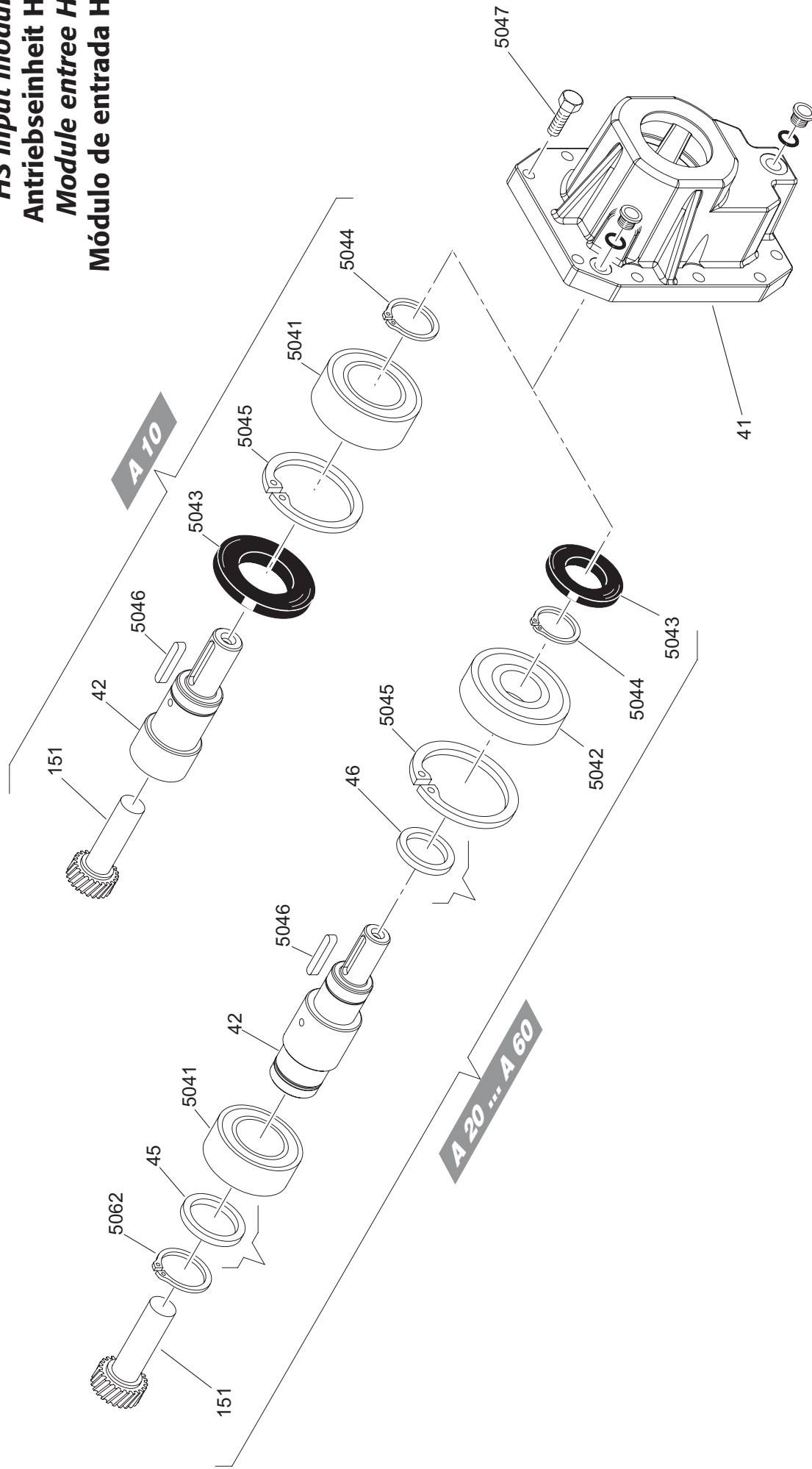

																	
	5027					5035					OR 6021		5034				
	A 10	A 20	A 30	A 41	A 50	A 60	A 70	A 80	A 90	5030	5033	A 70	A 80	A 90	A 10 ... A 30	A 41 ... A 90	A 41 ... A 90
P63	M6x20 M6x22	M6x20 M6x22	M8x25	M8x20 M8x25	M10x25 M10x30	M10x30	M12x35			M5x20	M8x20	M12x65			3475	3475	
P71	M6x20 M6x22	M6x20 M6x22	M8x25	M8x20 M8x25	M10x25 M10x30	M10x30	M12x35			M5x20	M8x20	M12x65			3475	3475	
P80	M6x20 M6x22	M6x20 M6x22	M8x25	M8x20 M8x25	M10x25 M10x30	M10x30	M12x35	M12x35	M16x50	M6x25	M10x22	M12x65	M12x65	M16x85	3575	3575	
P90	M6x20 M6x22	M6x20 M6x22	M8x25	M8x20 M8x25	M10x25 M10x30	M10x30	M12x35	M12x35	M16x50	M6x25	M10x22	M12x65	M12x65	M16x85	3575	3575	
P100	M6x20 M6x22	M6x20 M6x22	M8x25	M8x20 M8x25	M10x25 M10x30	M10x30	M12x35	M12x35	M16x50	M6x30	M12x30	M12x65	M12x65	M16x85	3575	3800	
P112				M8x20 M8x25	M10x25 M10x30	M10x30	M12x35	M12x35	M16x50	M8x25	M12x50	M12x65	M12x65	M16x85		3800	M12

																	
	5021					5022					5421			5422	5024	5026	5025
	5023	A 10	A 20	A 30	A 41	A 50	A 60	A 70	A 80	A 90	A 41 ... A 90	A 70	A 80	A 90	A 41 ... A 90	A 41 ... A 90	
P63	25x42x7 L	6006	6005-2RS 6005-2RS WT	6006	6006	6006	6006	6006	6006	6006	6006	6006	6006	6006	25	30	47
P71	25x42x7 L	6006	6005-2RS 6005-2RS WT	6006	6006	6006	6006	6006	6006	6006	6006	6006	6006	6006	25	30	47
P80	40x62x7 L	6007 6007 ETN9	6007-2RS 6007-2RS WT 6007 ETN9	6007 6007 ETN9	6007 6007 ETN9	6007 6007 ETN9	6007 6007 ETN9	6007 6007 ETN9	6007 6007 ETN9	6007 6007 ETN9	6007 6007 ETN9	6007 6007 ETN9	6007 6007 ETN9	6007 6007 ETN9	40	35	68
P90	40x62x7 L	6007 6007 ETN9	6007-2RS 6007-2RS WT 6007 ETN9	6007 6007 ETN9	6007 6007 ETN9	6007 6007 ETN9	6007 6007 ETN9	6007 6007 ETN9	6007 6007 ETN9	6007 6007 ETN9	6007 6007 ETN9	6007 6007 ETN9	6007 6007 ETN9	6007 6007 ETN9	40	35	68
P100 P112	45x72x8 L	6007 6007 ETN9	6009-2RS 6009-2RS WT 6012-2RS	6007 6007 ETN9	6209	6209	6209	6209	6209	6209	6209	6209	6209	6209	45	35	75
P132	55x80x8 L	6012-2RS WT	6012-2RS WT		6209	6209	6209	6209	6209	6209	6209	6209	6209	6209	60	45	95

Modulo entrata HS
HS input module
Antriebseinheit HS
Module d'entree HS
Módulo de entrada HS



Pos.	Descrizione	Description	Benennung	Description	Description	Descrizione
41	Coperchio	Cover	Deckel	Couvercle	Tapa	
42	Albero veloce	Input shaft	Antriebswelle	Arbre rapide	eje de salida	
45	Distanziale	Spacer ring	Distanzring	Entretoise	Distanciador	
46	Distanziale	Spacer ring	Distanzring	Entretoise	Distanciador	
151	Pignone	Pinion gear	Ritzel	Pignon	Piñon	

		5041	5042		5043		5044		5062		5045		5047
A 10	3206-2RS		5042	35x62x7 L	5043	5x5x35 A	30	62	5062	62	5045	T.E. M6x20 T.E. M6x22	
A 20	6007	6206-2RS	6206-2RS	30x52x7 L	5043	6x6x35 A	30	35	5062	62	5045	T.E. M6x20 T.E. M6x22	
A 30	6207	6306-2RS	6306-2RS	30x52x7 L	5043	6x6x35 A	30	35	5062	72	5045	T.E. M8x25 T.E. M8x30	
A 41	6007	6206-2RS	6206-2RS	30x52x7 DL	5043	6x6x35 A	30	35	5062	62	5045	T.E. M8x25 T.E. M6x20	
A 50	⁶²¹⁰ i = 18.9...21.1 NUP 210 i = 2.6...16.6	6308-2RS	6308-2RS	40x62x7 DL	5043	8x7x45 a	40	50	5062	90	5045	T.E. M10x35	
A 60	6310	6309-2RS	6309-2RS	45x72x8 DL	5043	8x7x50 A	45	50	5062	100	5045	T.E. M10x35	

Modulo entrata HS
HS input module
Antriebseinheit HS
Module d'entree HS
Módulo de entrada HS

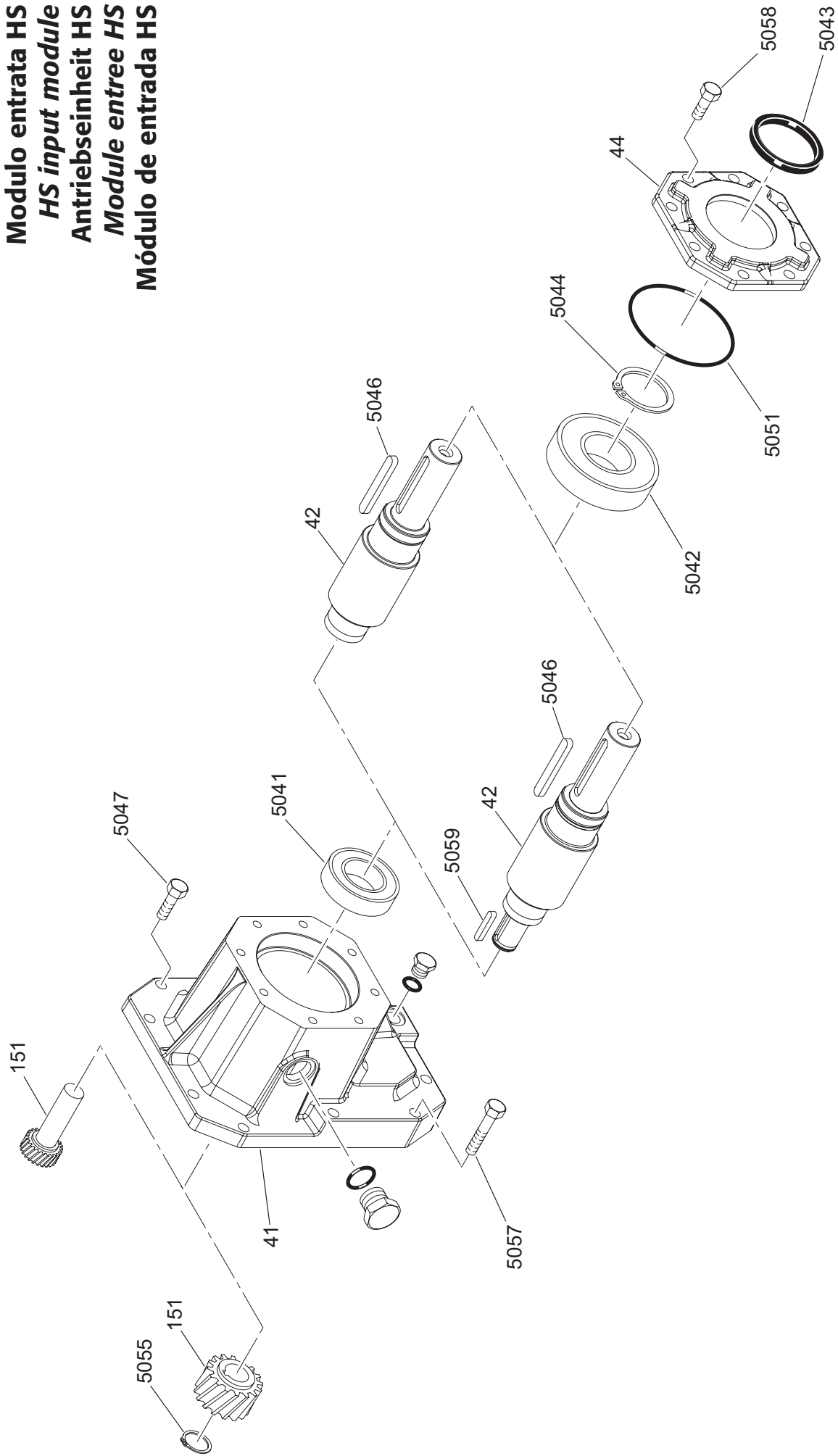

Pos.	Descrizione	Description	Benennung	Description	Benennung	Description
41	Coperchio	Cover	Deckel	Couvercle	Deckel	Tapa
42	Albero veloce	Input shaft	Antriebswelle	Arbre rapide	Antriebswelle	eje de salida
44	Cappello per cuscinetto	Bearing holder	Deckel	Capuchon	Deckel	Sombrerete para rodamiento
151	Pignone	Pinion gear	Ritzel	Pignon	Ritzel	Piñon

5041		5042		5043		5046		5059	
A 70	A 80	A 90	A 70 - A 80	A 90	A 70 - A 80	A 90	A 70 - A 80	A 90	A 70 - A 80
NJ2210	NJ310 NJ2212	NJ2214E	6312 6312-2RS 6312-2RS WT	6320 6320-2RS 6320-2RS WT	60x90x8 DL	100x120x12 DL	12x8x90 A	18x11x120 A	8x7x45 A
									8x7x45 A 14x9x57 C

5044		5055		5047		5057		5058	
A 70 - A 80	A 90	A 70	A 80	A 90	A 70 - A 80	A 90	A 70	A 90	A 70 - A 80
60 → 3 ←	100 → 4 ←	30	48	M12x40	M12x65	M12x70	M16x80	M12x30	M16x40

	OR 5051
A 70 - A 80	A 90
3500	3850

R0				
Descrizione	Description	Benennung	Description	Descripción

Questa pubblicazione annulla e sostituisce ogni precedente edizione o revisione. Ci riserviamo il diritto di apportare modifiche senza preavviso. E' vietata la riproduzione anche parziale senza autorizzazione.

This publication cancels and replaces any previous edition and revision. We reserve the right to implement modifications without notice. This catalogue cannot be reproduced, even partially, without prior consent.

Diese Veröffentlichung annulliert und ersetzt jeder hergehende Edition oder Revision. BONFIGLIOLI behält sich das Recht vor, Änderungen ohne vorherige Informationen durchzuführen.

Cette publication annule et remplace toutes les autres précédentes. Nous nous réservons le droit d'apporter toutes modifications à nos produits. La reproduction et la publication partielle ou totale de ce catalogue est interdite sans a autorisation.

Esta publicación anula y sustituye toda anterior edición o revisión. Nos reservamos el derecho de aportar modificaciones sin previo aviso. Se prohíbe la reproducción incluso parcial sin autorización.

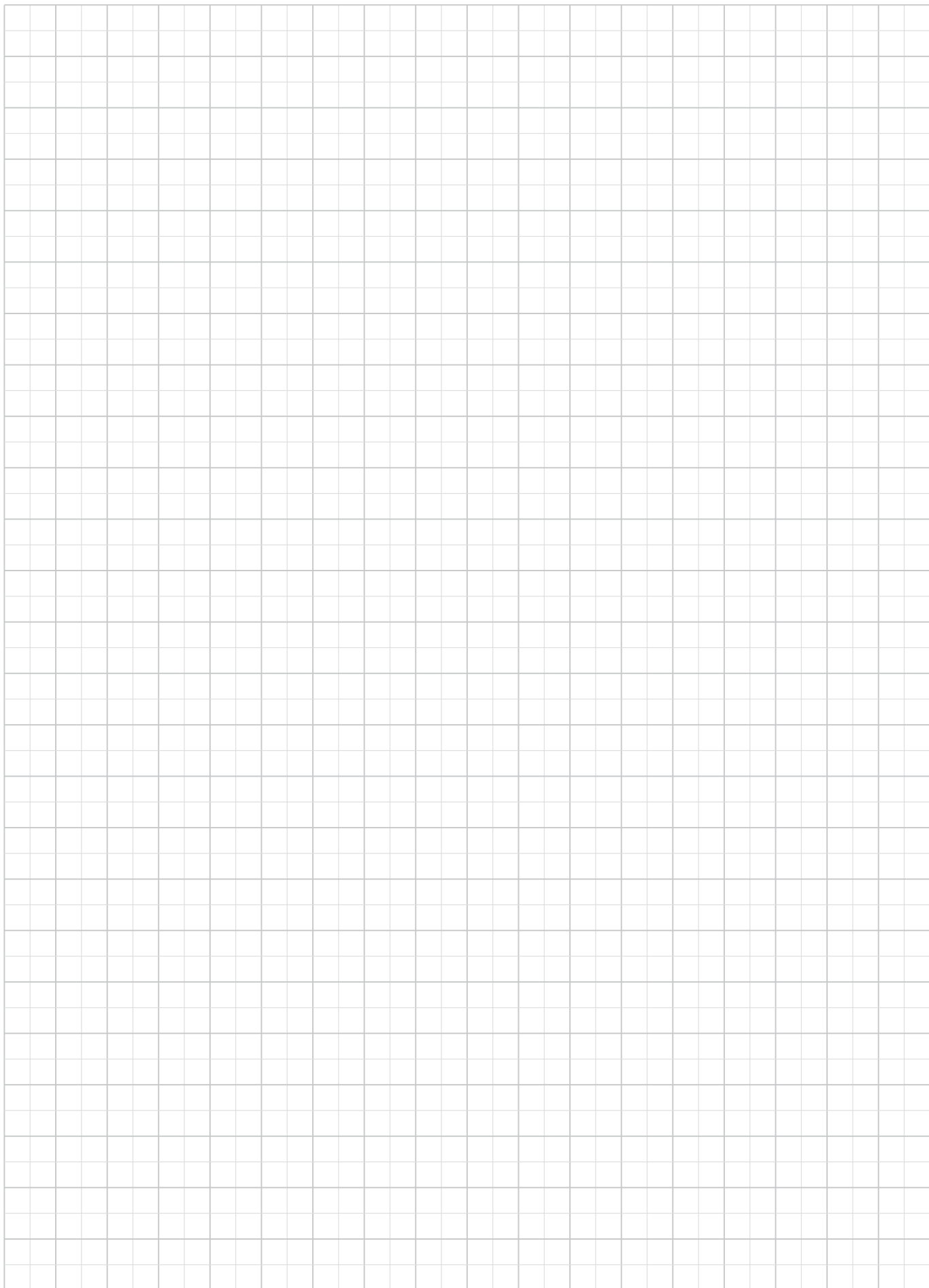

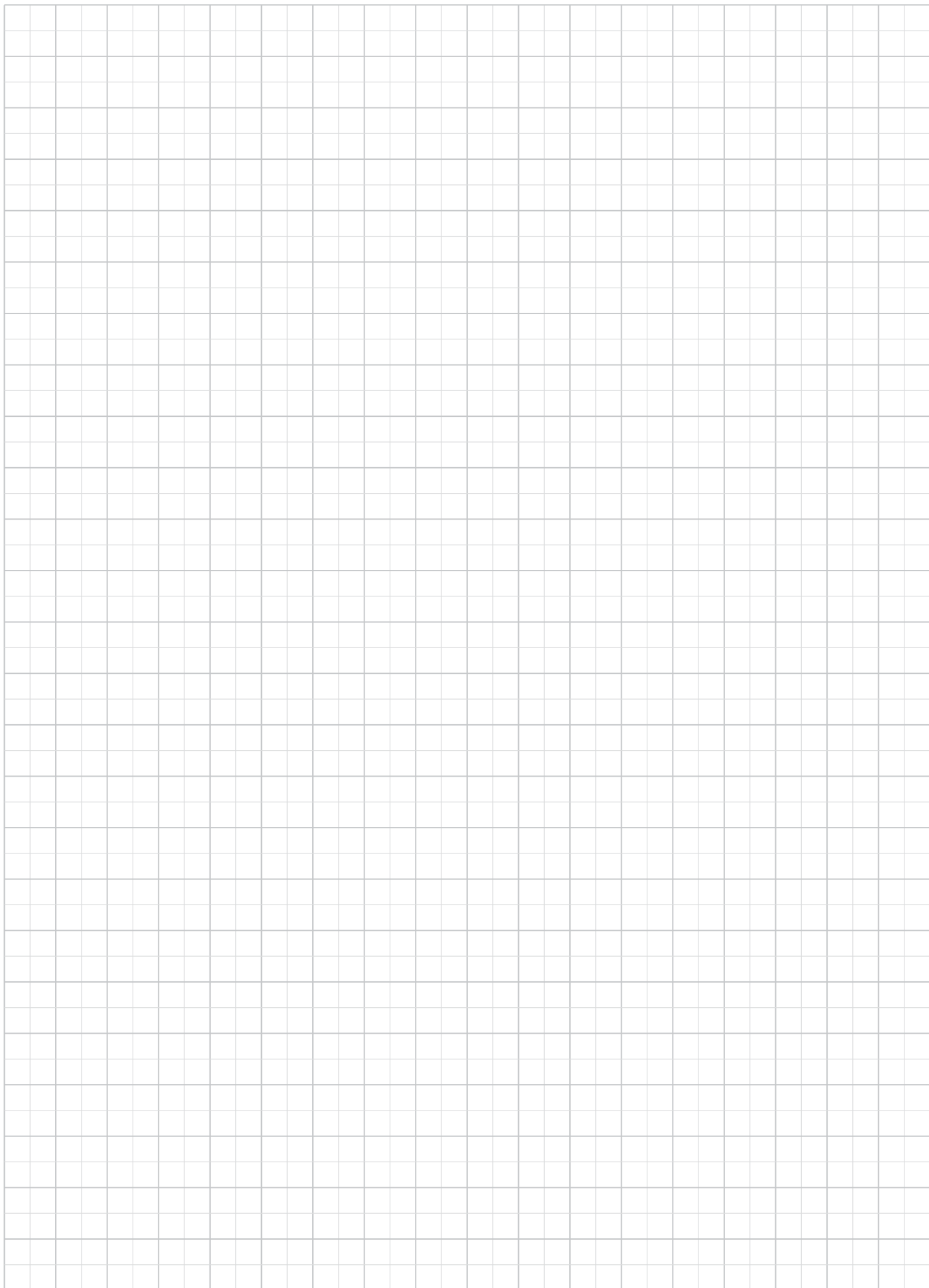

Bonfiglioli Worldwide & BEST Partners

AUSTRALIA

BONFIGLIOLI TRANSMISSION (Aust) Pty Ltd.
48-50 Adderley St. (East) Auburn (Sydney) N.S.W. 2144
Tel. (+61) 2 8748 4400 - Fax (+61) 2 9748 8740
P.o. Box 6705 Silverwater NSW 1811
www.bonfiglioli.com.au - sales@bonfiglioli.com.au

AUSTRIA

MOLL MOTOR GmbH
Industriestrasse 8 - 2000 Stockerau
Tel. (+43) 2266 63421+DW - Fax (+43) 6342 180 - Tlx 61 32 22 348 Molla
www.mollmotor.at - office@mollmotor.at

BELGIUM

N.V. ESCO TRANSMISSION S.A.
Culliganlaan 3 - 1831 Machelem Diegem
Tel. 0032 2 7204880 - Fax 0032 2 7212827 - Tlx 21930 Escopo B
www.escotrans.be - info@escotrans.be

BRASIL

ATI BRASIL
Rua Omlio Monteiro Soares, 260 - Vila Fanny - 81030-000
Tel. (+41) 334 2091 - Fax (+41) 332 8669
www.atibrasil.com.br - vendas@atibrasil.com.br

CANADA

BONFIGLIOLI CANADA INC.
2-7941 Jane Street - Concord, ONTARIO L4K 4L6
Tel. (+1) 905 7384466 - Fax (+1) 905 7389833
www.bonfigliolicanada.com - sales@bonfigliolicanada.com

CHINA

BONFIGLIOLI DRIVES (SHANGHAI) CO. LTD.
No. 8 Building, 98 Tian Ying Road - Qingpu District, Shanghai, PRC 201700
Tel. +86 21 69225500 - Fax +86 21 69225511
www.bonfiglioli.cn - linkn@bonfiglioli.com.cn

FRANCE

BONFIGLIOLI TRANSMISSIONS S.A.
14 Rue Eugène Pottier BP 19
Zone Industrielle de Moimont II - 95670 Marly la Ville
Tel. (+33) 1 34474510 - Fax (+33) 1 34688800
www.bonfiglioli.fr - btf@bonfiglioli.fr

GERMANY

BONFIGLIOLI DEUTSCHLAND GmbH
Hamburger Straße 18 - 41540 Dormagen
Tel. (+49) 2133 50260 - Fax (+49) 2133 502610
www.bonfiglioli.de - info@bonfiglioli.de

GREAT BRITAIN

BONFIGLIOLI UK Ltd
Unit 3 Colemeadow Road - North Moons Moat
Redditch, Worcestershire B98 9PB
Tel. (+44) 1527 65022 - Fax (+44) 1527 61995
www.bonfiglioli.co.uk - marwaha@bonfiglioli.com

BONFIGLIOLI (UK) LIMITED
5 Grosvenor Grange - Woolston - Warrington, Cheshire WA1 4SF
Tel. (+44) 1925 852667 - Fax (+44) 1925 852668
www.bonfiglioliuk.co.uk - sales@bonfiglioliuk.co.uk

GREECE

BONFIGLIOLI HELLAS S.A.
O.T. 48A T.O. 230 - C.P. 570 22 Industrial Area - Thessaloniki
Tel. (+30) 2310 796456 - Fax (+30) 2310 795903
www.bonfiglioli.gr - info@bonfiglioli.gr

HOLLAND

ELSTO AANDRIJFTECHNIEK
Loosterweg, 7 - 2215 TL Voorhout
Tel. (+31) 252 219 123 - Fax (+31) 252 231 660
www.elsto.nl - info@elsto.nl

HUNGARY

AGISYS AGITATORS & TRANSMISSIONS Ltd
2045 Törökbálint, Tó u.2. Hungary
Tel. +36 23 50 11 50 - Fax +36 23 50 11 59
www.agisys.hu - info@agisys.com

INDIA

BONFIGLIOLI TRANSMISSIONS PVT Ltd.
PLOT AC7-AC11 Sidco Industrial Estate
Thirumudivakkam - Chennai 600 044
Tel. +91(0)44 24781035 / 24781036 / 24781037
Fax +91(0)44 24780091 / 24781904
www.bonfiglioli.co.in - bonfig@vsnl.com

ITALY

A.T.I. di Morganti E.C. sas 
Via Pistoiese 219 - 50047 Prato (PO)
Tel. 0574/6961 - Fax 0574/790996
www.atimorganti.it - ati.morganti@texnet.it

BONETTI LUIGI SRL 
Strada Padana Superiore verso VR n.7 - 36100 Vicenza (VI)
Tel. 0444/563120 - Fax 0444/961979
www.bonettimotoriduttori.com - bonetti.luigi@libero.it

CASA DEL CUSCINETTO SAS di Castignoli e C. 
Strada Val Nure 18/a - 29100 Piacenza (PC)
Tel. 0523/755518 - 0523/756315 - Fax 0523/457804
www.casadelcuscinetto.net - antonio@casadelcuscinetto.net

CENTO TRASMISSIONI SRL 
Via Friuli 23 - 40060 Osteria Grande (BO)
Tel. 051/6958222 - Fax 051/6958253
www.centotrasmissioni.com - cento@centotrasmissioni.com

CONTASTA COMPONENTI SRL 
di Franca Di Clemente e Figli
Via Po 65/67 - Zona Comm. 66020 S.Giovanni Teatino (CH)
Tel. 085/4462696 - Fax 085/4461754
www.grupprofitt.it - grupprofitt@grupprofitt.it

D.L. di Danielli B e Lolli G. SRL 
Via Fucini 2 - 40132 Bologna
Tel. 051/6177611 - Fax 051/6177630
www.danielliolli.it - info@danielliolli.it

EGA TECNIC SRL 
Via Maccani 171/2 - 38100 Trento
Tel. 0461 822176 - Fax 0461 821643
www.egatecnic.it - info@egatecnic.it

FIMU S.R.L. 
Via Artigianato - 25128 Savignano (CN)
Tel. 0172/713542 - Fax 0172/715489
www.fimusrl.com - fimu@fimusrl.com

FITMA S.R.L. 
Viale del Commercio 10 - 37042 Caldiero (VR)
Tel. 045/6132511 - Fax 045/6150270
www.fitma.it - fitma@fitma.it

F.M.I. FRANCESCHI S.R.L. 
Strada Baganzola 28/a - 43100 Parma
Tel. 0521/992200 - Fax 0521/987303
www.fimiparma.it - fmi@fimiparma.it

INDUSTRIAL FURNITURE MORO SNC 
Via del Da Prata 34 - 31100 Treviso
Tel. 0422 428835 - Fax 0422/428830
www.morotrevise.com - info@morotrevise.com

MICAR Snc di Sandro Arminio e C. 
Via Rosso di S. Secondo, 15 - 20134 Milano
Tel. 02/7491091 - Fax 02/70126372
www.micar.it - info@micar.it

MINETTI SPA FILIALE DI BERGAMO 
Via Canovine, 14 - 24100 Bergamo
Tel. 035/327111 - Fax 035/316767
www.minettigroup.com - minettibergamo@minettigroup.com

MINETTI SPA FILIALE DI BRESCIA 
Via G. di Vittorio, 38 - Z.I. - 25128 Brescia
Tel. 030/3582734 - Fax 030/3582760
www.minettigroup.com - minettibrescia@minettigroup.com

S.I.R.I. SRL 
Via Dell'Industria 9 - 04011 Aprilia (LT)
Tel. 06/9206291 - Fax 06/9258643
www.sirisrl.com - info@sirisrl.com

SAROK ITALIA SRL 
Via Valsugana, 4 - 22053 Lecco (CO)
Tel. 0341/357811 - Fax 0341/283096
www.sarok.it - sarokitalia@sarok.it

SAROK DUE SRL 
Via 1 Maggio 9/11 - 20028 S. Vittore Olona (MI)
Tel. 0331/423911 - Fax 0331/423942
www.sarok.it - sarok2@tin.it

T.I.M. Tecn.Ind. Modenesi 
Via Franz Leahr 25 - 41100 Modena
Tel. 059/282500 - Fax 059/282404
www.timmodena.com - timmodena@timmodena.com

TECHNOBI SRL 
Via Lazio, 65 - 20090 Buccinasco (MI)
Tel. 02/45712362 - Fax 02/45712219
www.technobi.it - technobi@libero.it

TECNICA INDUSTRIALE SRL 
S.P. 231 km1 ex S.S.98 Km 80,176 - 70026 Modugno (BA)
Tel. 080/5367089 - 080/5367090 - Fax 080/5367091
www.tecnicaindustriale.it - info@tecnicaindustriale.it

TECNOFORNITURE SRL 
Via Pasubio 106 - 63037 Porto d'Ascoli (AP)
Tel. 0735/76171 - Fax 0735/655266
www.tecnoforniture.it - info@tecnoforniture.it

V.B. Moto Trasmissioni s.n.c. 
di Volpe E. E Bianchi P. E. C.
Via Enzo Ferrari 335 - 47037 Cesena (FO)
Tel. 0547/630610 - Fax 0547/630615
www.vbmototrasmissioni.it - info@vbmototrasmissioni.it

VENETA BEARINGS SRL 
Via Torino 15 - 35035 Mestrino (PD)
Tel. 049/9001944 - 049/9001549 - Fax 049/9001543
www.venetabearings.it - info@venetabearings.it

NEW ZEALAND

SAECO BEARINGS TRANSMISSION
36 Hastie Avenue, MangerePo Box 22256, Otahuhu - Auckland
Tel. +64 9 634 7540 - Fax +64 9 634 7552
mark@saeco.co.nz

POLAND

POLPACK Sp. z o.o. - Ul. Chrobrego 135/137 - 87100 Torun
Tel. 0048.56.6559235 - 6559236 - Fax 0048.56.6559238
www.polpack.com.pl - polpack@polpack.com.pl

RUSSIA

FAM
57, Maly Prospekt, V.O. - 199048, St. Petersburg
Tel. +7 812 3319333 - Fax +7 812 3271454
www.fam-drive.ru - info@fam-drive.ru

SPAIN

TECNOTRANS SABRE S.A.
Pol. Ind. Zona Franca sector C, calle F, n°6 08040 Barcelona
Tel. (+34) 93 4478400 - Fax (+34) 93 3360402
www.tecnotrans.com - tecnotrans@tecnotrans.com

SOUTH AFRICA

BONFIGLIOLI POWER TRANSMISSION Pty Ltd.
55 Galaxy Avenue, Linbro Business Park - Sandton
Tel. (+27) 11 608 2030 OR - Fax (+27) 11 608 2631
www.bonfiglioli.co.za - bonfigsales@bonfiglioli.co.za

SWEDEN

BONFIGLIOLI SKANDINAVIEN AB
Kontorsgatan - 234 34 Lomma
Tel. (+46) 40 412545 - Fax (+46) 40 414508
www.bonfiglioli.se - info@bonfiglioli.se

THAILAND

K.P.T MACHINERY (1993) CO.LTD.
259/83 Soi Phiboonves, Sukhumvit 71 Rd. Phrakhanong-nur,
Wattana, Bangkok 10110
Tel. 0066.2.391030/7111998
Fax 0066.2.7112852/3811308/3814905
www.kpt-group.com - sales@kpt-group.com

USA

BONFIGLIOLI USA INC
1000 Worldwide Boulevard - Hebron, KY 41048
Tel.: (+1) 859 334 3333 - Fax: (+1) 859 334 8888
www.bonfiglioliusa.com
industrialsales@bonfiglioliusa.com
mobilesales@bonfiglioliusa.com

VENEZUELA

MAQUINARIA Y ACCESORIOS IND.-C.A.
Calle 3B - Edif. Comindu - Planta Baja - Local B
La Urbina - Caracas 1070
Tel. 0058.212.2413570 / 2425268 / 2418263
Fax 0058.212.2424552 - Tlx 24780 Maica V
www.maica-ve.com - maica@telcel.net.ve

HEADQUARTERS

BONFIGLIOLI RIDUTTORI S.p.A.
Via Giovanni XXIII, 7/A
40012 Lippo di Calderara di Reno
Bologna (ITALY)
Tel. (+39) 051 6473111
Fax (+39) 051 6473126
www.bonfiglioli.com
bonfiglioli@bonfiglioli.com

SPARE PARTS BONFIGLIOLI

B.R.T.
Via Castagnini, 2-4
Z.I. Bargellino - 40012
Calderara di Reno - Bologna (ITALY)
Tel. (+39) 051 727844
Fax (+39) 051 727066
www.brtonfiglioliricambi.it
brt@bonfiglioli.com

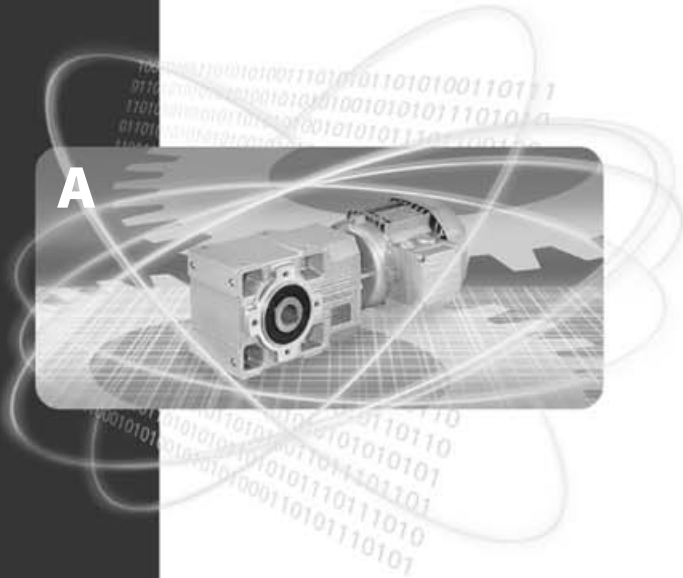

www.bonfiglioli.com

